

ERD ELECTRIC ROD-STYLE ACTUATOR

ENDURANCE TECHNOLOGYSM
A Tolomatic Design Principle

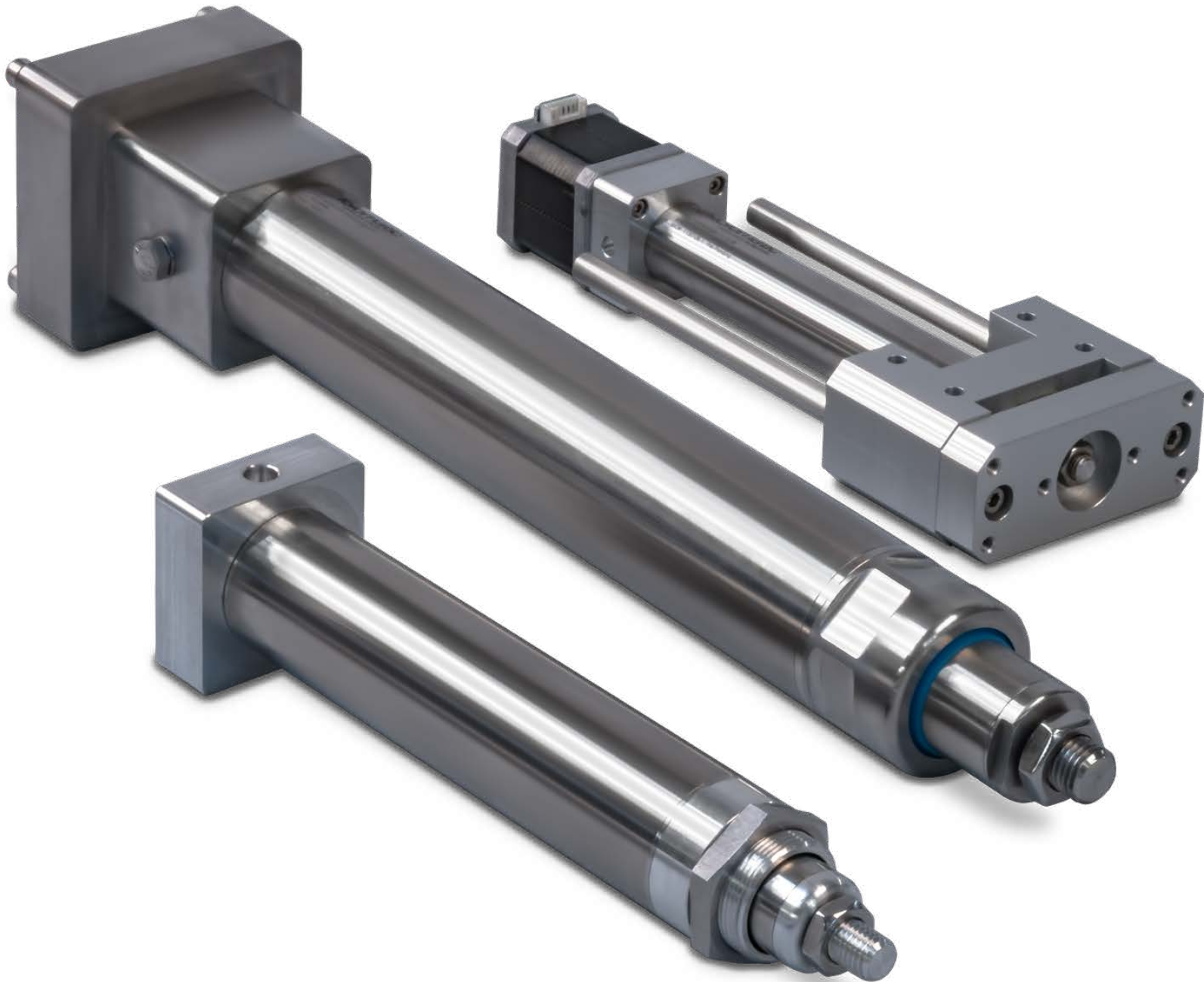

ERD – Electric Rod-Style Actuator

The ERD is an economical rod-style electric actuator designed as an alternative to pneumatic cylinders, a cost effective actuator for general automation and an option for automating manual processes. In addition, the ERD is available with all stainless steel and IP69K options which makes it the ideal hygienic actuator for the food & beverage processing environment.

Wash-down* Stainless Steel, IP69k



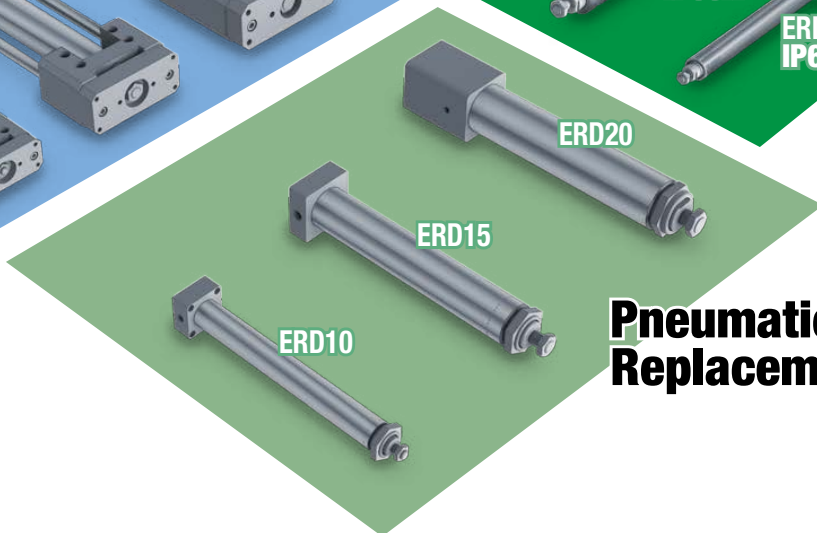
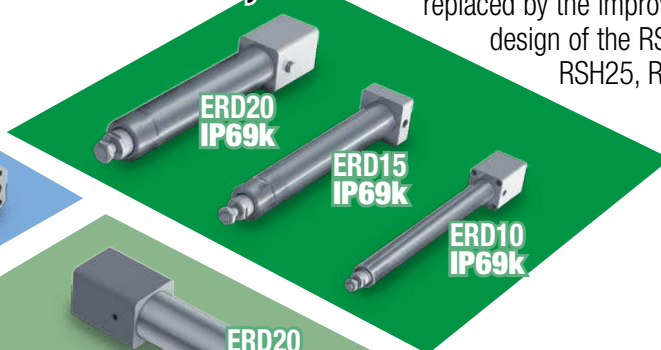
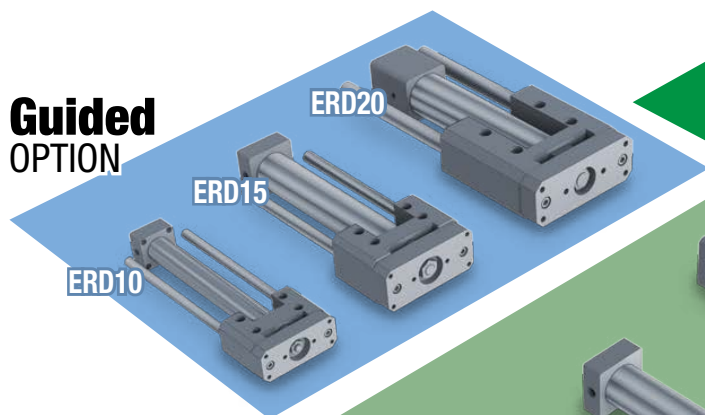

*ERD22, ERD25, ERD30 are replaced by the improved design of the RSH22, RSH25, RSH30

Guided OPTION



Pneumatic Replacement

TOLOMATIC'S ELECTRIC ROD-STYLE ACTUATORS

	ERD	RSH	RSA	RSX	GSA	IMA
						
	Rod-Style Actuator	Hygienic Rod-Style Actuator	Rod-Style Actuator	Rod-Style Actuator	Guided Rod-Style Actuator	Integrated Servo Actuator
Force up to:	2.22 kN (500 lbf)	35 kN (7,943 lbf)	58 kN (13,039 lbf)	222.4 kN (50,000 lbf)	4.23 kN (950 lbf)	35.8 kN (8,044 lbf)
Speed up to:	1,016 mm/sec (40 in/sec)	498 mm/sec (19.6 in/sec)	3,124 mm/sec (123 in/sec)	760 mm/sec (29.9 in/sec)	3,124 mm/sec (123 in/sec)	1,334 mm/sec (52.5 in/sec)
Stroke Length up to:	609 mm (24 in)	1,219 mm (48 in)	1,524 mm (60 in)	890 mm (35 in)	914 mm (36 in)	457 mm (18 in)
Screw/Nut Type	Solid, Ball & Roller	Ball & Roller	Solid, Ball & Roller	Roller	Solid & Ball	Ball & Roller
<i>For complete information see www.tolomatic.com or literature number:</i>						
Literature Number:	2190-4000	2100-4010	3600-4166	2171-4001	3600-4166	2700-4000

(Not all models deliver maximum values listed, i.e.: Maximum thrust may not be available with maximum speed)

ERD – Applications

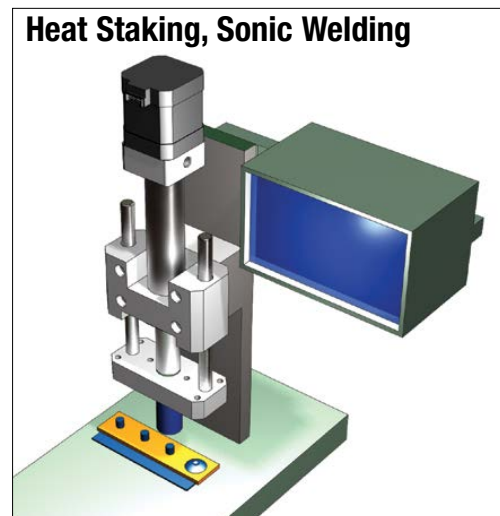
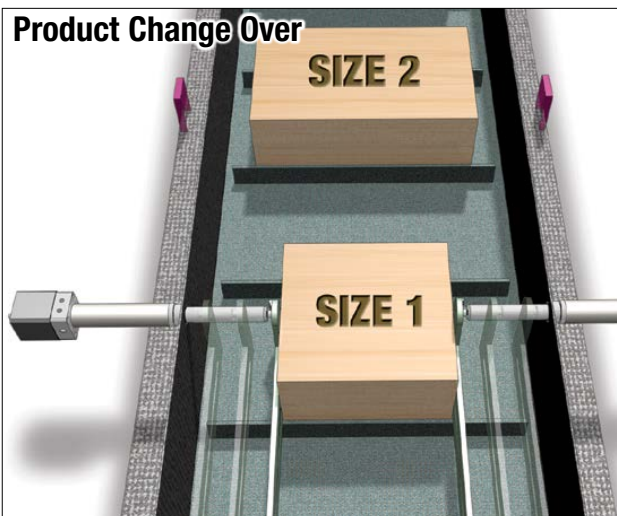
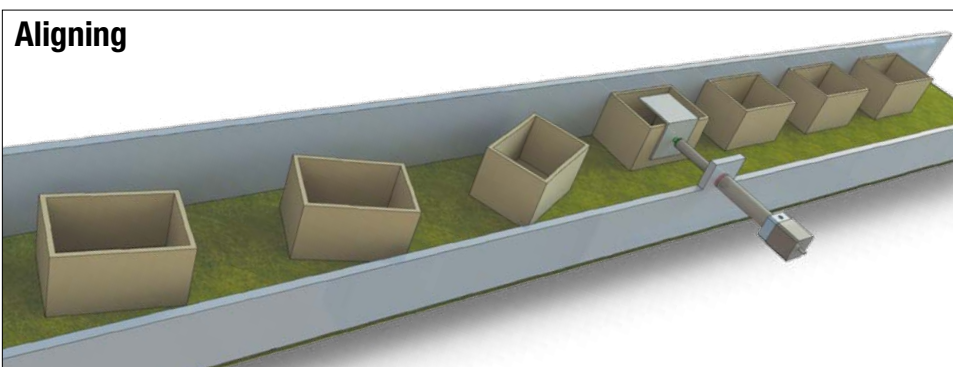
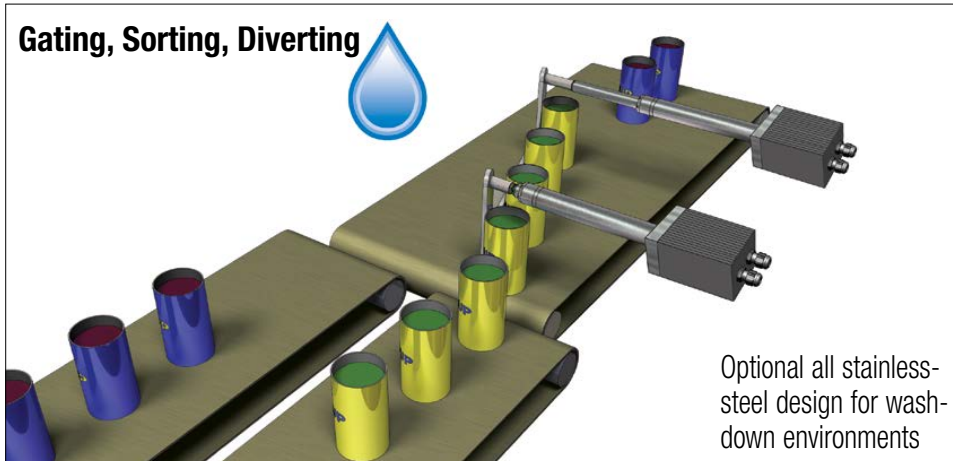

CONTENTS

What is the ERDERD_2

Rod-Style Actuators . . .ERD_2

ApplicationsERD_3

FEATURES

ERDERD_4

ERD SSERD_6

SPECIFICATIONS

ERDERD_7

PERFORMANCE

ERDERD_9

GD2ERD_14

DIMENSIONS

ActuatorERD_16

Options: IP67, FFG . . .ERD_17

SRE, CLV, ALCERD_18

FM2,ERD_19

TRR, PCDERD_20

SS2ERD_21

GD2ERD_22

Alternative Motors . . .ERD_23

SWITCHESERD_24

Appl. Data Worksheet ERD_26

Selection Guidelines . .ERD_27

Service PartsERD_28

OrderingERD_29

Other Applications:

- Aligning
- Animation
- Assembly
- Automatic tool changers
- Automotive
- Converting
- Conveyors
- Diverting
- Fillers
- Formers
- Gating
- Heat staking
- Laser positioning
- Material handling systems
- Medical equipment
- Motion simulators
- Open / close doors
- Packaging equipment
- Parts clamping
- Patient lifts
- Pick & place
- Plate positioning change
- Press fit
- Product changeover
- Product test simulations
- Robot manipulator arms
- Sonic welding
- Sorting
- Table positioning
- Tension control
- Test stands
- Volumetric pumps
- Web guidance
- Wire winding

ERD – ELECTRIC ROD-STYLE ACTUATOR

ENDURANCE TECHNOLOGYSM

Endurance Technology features are designed for maximum durability to provide extended service life.

A Tolomatic Design Principle

The ERD is an economical rod-style electric actuator designed as an alternative to pneumatic cylinders and an option for automating manual processes. The ERD is compatible with many NEMA & metric mount stepper and servo motors to create a flexible, powerful electric actuator solution. Built-to-order in stroke lengths up to 1.219 m (48").

MULTIPLE SCREW TECHNOLOGIES

YOU CAN CHOOSE:

- Solid nuts of bronze (15, 20 sizes) or engineered resins (10, 15 sizes) offer quiet performance at the lowest cost
- Ball nuts offer efficiency, longer life, and higher force capability

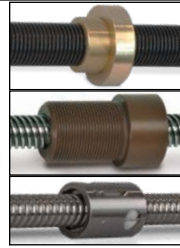

THREADED NOSE MOUNT WITH JAM NUT

- Metric threads
- Convenient mounting for many applications (10, 15, 20 sizes)



THREADED ROD END

- Compatible with many commercially available metric rod end accessories
- Standard metric threads
- Male threads



STAINLESS-STEEL THRUST TUBE

300 Series stainless-steel thrust tube provides high rigidity and corrosion resistance

NOSE BEARING

- Engineered resins for smooth operation
- Provides critical support of thrust rod

300 SERIES STAINLESS-STEEL MAIN TUBE

300 Series stainless-steel main tube provides high rigidity and corrosion resistance

INTERNAL MAGNET

This standard feature accommodates reed and solid state switches anywhere on the main tube

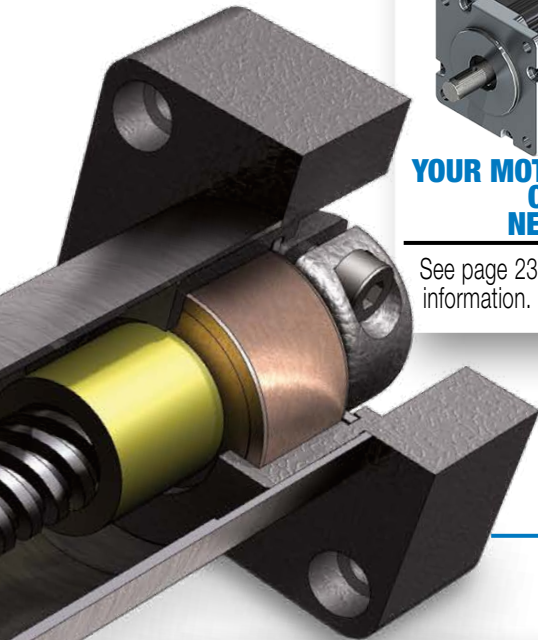

MOTOR ORIENTATION

LMI - Inline

Inline option directly couples the driving shaft and is typically a one-piece housing construction for optimum alignment and support of the motor

RP - Reverse parallel

Reverse-parallel option minimizes the overall length and offers a belt reduction drive with a 1:1 or 2:1 ratio.



OPTIONS

• INTERNAL ANTI-ROTATE (ARI)

Available for 15, 20 sizes only.



• TRUNNION MOUNT (TRR)

For applications that require pivoting, 300 series stainless steel construction. Available on all sizes



• REAR CLEVIS MOUNT (PCD)

For applications that require rear pivot, (Available for 15, 20 sizes with **R/P** mounting only)



• FOOT MOUNT (FM2)*

For applications that require bottom mounting, 300 series stainless steel construction. Available on all sizes



• FRONT FLANGE MOUNT (FFG)*

For front mounting applications, 300 series stainless steel construction. Available on all sizes

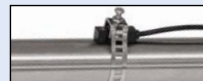

• SWITCHES*

Choose from: Reed, Solid State PNP or NPN, all available in normally open. Available on all sizes



***NOTE: Foot Mount, Front Flange Mount and Switches are shipped together with the actuator but are not installed by Tolomatic.**

• GUIDE (GD2)

For applications that require anti-rotation, or guidance and load bearing. Tooling plate and guide block made of lightweight aluminum and high performance polymer bearings. Available on all sizes.



INTEGRAL GUIDE RODS AND BEARINGS

- Stainless-steel guide rods provide high rigidity and low deflection
- Four composite bearings support the load for smooth consistent motion

SS HYGIENIC OPTION

ALL 300 SERIES STAINLESS STEEL, IP69K

The all 300 series stainless-steel ERD for 10, 15 & 20 sizes incorporates hygienic design principles. With an IP69K rating ERD-SS actuators are built-to-order in stroke lengths up to 0.6 m (24").

ENDURANCE TECHNOLOGYSM

A Tolomatic Design Principle

Endurance Technology features are designed for maximum durability to provide extended service life.

SS1 OPTION ACTUATOR

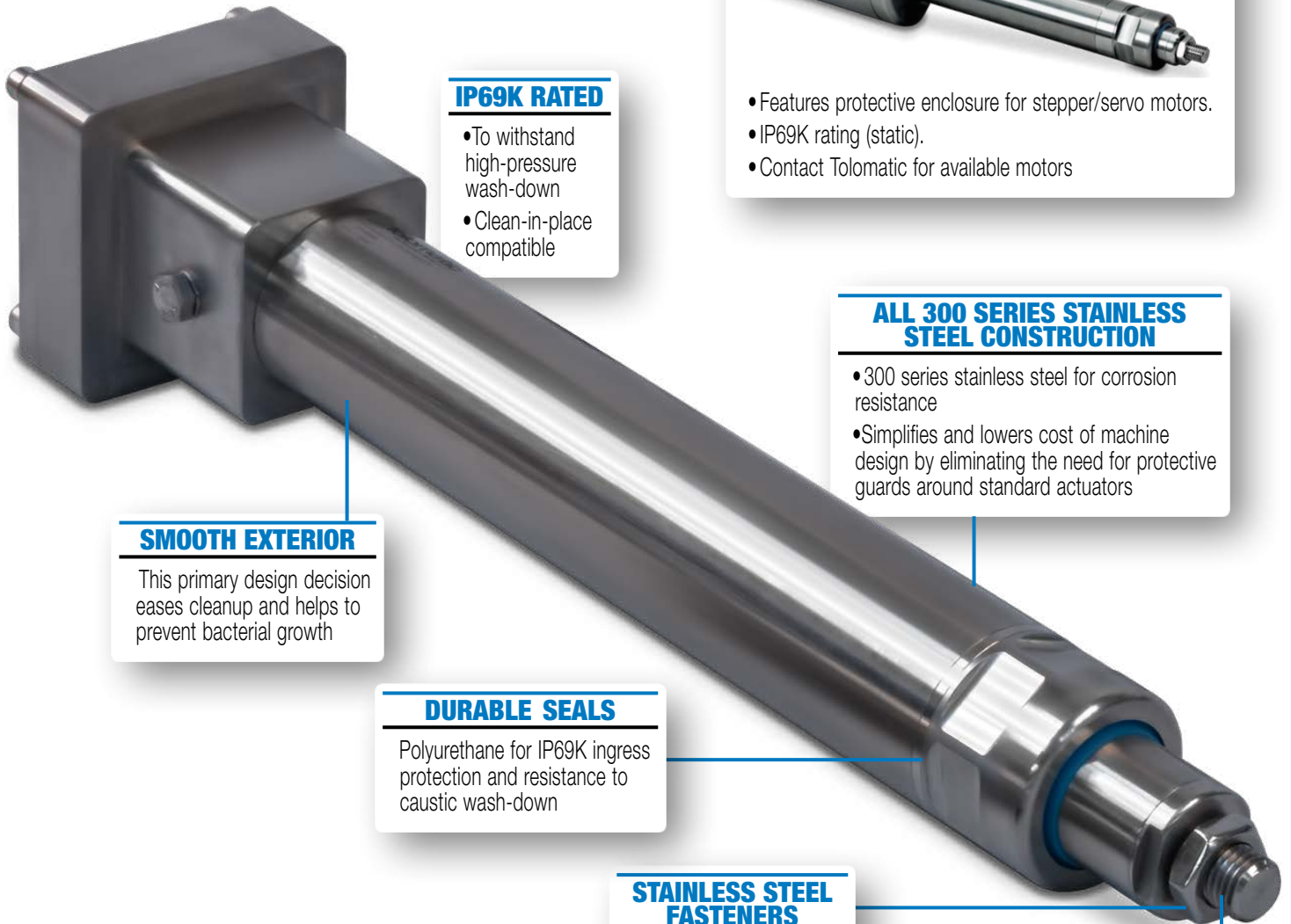

IP69K RATED

- To withstand high-pressure wash-down
- Clean-in-place compatible

SMOOTH EXTERIOR

This primary design decision eases cleanup and helps to prevent bacterial growth

DURABLE SEALS

Polyurethane for IP69K ingress protection and resistance to caustic wash-down

STAINLESS STEEL FASTENERS

- Standard metric threads
- Hex fasteners for sturdy construction without potential particle collection areas

THREADED ROD END

- Compatible with many commercially available metric rod end accessories
- Standard metric threads
- Male threads

SS2 ENCLOSED MOTOR DESIGN



- Features protective enclosure for stepper/servo motors.
- IP69K rating (static).
- Contact Tolomatic for available motors

ALL 300 SERIES STAINLESS STEEL CONSTRUCTION

- 300 series stainless steel for corrosion resistance
- Simplifies and lowers cost of machine design by eliminating the need for protective guards around standard actuators



NOTE: ERD22, ERD25, ERD30 ARE REPLACED BY THE IMPROVED DESIGN OF THE RSH22, RSH25, RSH30

ERD – Electric Rod-Style Actuator



SIZE: ALL

SPECIFICATIONS

SPECIFICATIONS (US conventional measurement)

ERD SIZE*	MAXIMUM STROKE**	SCREW CODE	LEAD	LEAD ACCURACY	BACKLASH	MAXIMUM THRUST	DYNAMIC LOAD RATING	INERTIA		
								LMI	RP	Per Inch
								Base	Base	
in	in/rev	in/ft	in	lbf	lbf	lb-in ²	lb-in ²	lb-in ²		
10	10	SN01	1.000	0.007	0.007	40	NA	0.0022	–	0.0006
		SN02	0.500	0.007	0.007	40	NA	0.0022	–	0.0006
		SN05	0.200	0.007	0.007	40	NA	0.0022	–	0.0006
		BNM05	0.197	0.004	0.005	100	240	0.0040	–	0.0014
15	24	SN01	1.000	0.006	0.007	75	NA	0.0104	0.2101	0.0017
		SN02	0.500	0.005	0.007	75	NA	0.0104	0.2101	0.0017
		SN05	0.200	0.006	0.007	75	NA	0.0104	0.2101	0.0017
		BNM05	0.197	0.004	0.005	200	450	0.0178	0.2208	0.0044
		BNM10	0.394	0.004	0.005	200	400	0.0178	0.2208	0.0044
		BZ10	0.100	0.006	0.008	200	NA	0.0178	0.2208	0.0044
20	24	BNM05	0.197	0.004	0.005	500	900	0.0628	0.4102	0.0263
		BNM10	0.394	0.004	0.005	500	900	0.0628	0.4102	0.0263
		BNM20	0.788	0.004	0.004	500	2,248	0.0628	0.4102	0.0105
		BZ10	0.100	0.006	0.008	500	NA	0.0628	0.4102	0.0105

SPECIFICATIONS (metric measurement)

ERD SIZE*	MAXIMUM STROKE**	SCREW CODE	LEAD	LEAD ACCURACY	BACKLASH	MAXIMUM THRUST	DYNAMIC LOAD RATING	INERTIA		
								LMI	RP	Per 25mm
								Base	Base	
mm	mm/rev	mm/300mm	mm	N	N	kg-m ² x 10 ⁻⁶	kg-m ² x 10 ⁻⁶	kg-m ² x 10 ⁻⁶		
10	254.0	SN01	25.4	0.18	0.18	188	NA	0.64	–	0.18
		SN02	12.7	0.18	0.18	188	NA	0.64	–	0.18
		SN05	5.08	0.18	0.18	188	NA	0.64	–	0.18
		BNM05	5.00	0.10	0.13	445	1,068	1.16	–	0.41
15	609.6	SN01	25.4	0.15	0.18	334	NA	3.04	61.48	0.50
		SN02	12.7	0.13	0.18	334	NA	3.04	61.48	0.50
		SN05	5.08	0.15	0.18	334	NA	3.04	61.48	0.50
		BNM05	5.00	0.10	0.13	890	2,002	5.21	64.61	1.28
		BNM10	10.00	0.10	0.13	890	1,779	5.21	64.61	1.28
		BZ10	2.54	0.15	0.20	890	NA	5.21	64.61	1.28
20	609.6	BNM05	5.00	0.10	0.13	2,224	4,003	18.38	120.04	7.70
		BNM10	10.00	0.10	0.13	2,224	4,003	18.38	120.04	7.70
		BNM20	20.00	0.10	0.10	2,224	10,000	18.38	120.04	3.07
		BZ10	2.54	0.15	0.20	2,224	NA	18.38	120.04	3.07

*ERD22, ERD25, ERD30 are replaced by the improved design of the RSH22, RSH25, RSH30

**Longer stroke length modification available upon request.

SCREW CODE	DESCRIPTION
BNM	Ball Nut Metric
BZ	Bronze Nut
SN	Solid Nut

§Standard Temperature range	40° to 130° F (4.4° to 54.4° C)
†IP rating	40 (static) standard for 10, 15, 20 sizes

§Contact Tolomatic to review application for operations outside the standard temperature range.

†IP67 & IP69K hygienic actuators available

ERD – Electric Rod-Style Actuator



SIZE: ALL

SPECIFICATIONS

SPECIFICATIONS (US conventional measurement)

ERD SIZE*	MAXIMUM STROKE**	SCREW CODE	WEIGHT					WEIGHT (GD2 adder)	
			LMI (AL)	RP (AL)	RP (SS)	(SS2 adder)	Per Inch	Base	Per Inch
			Base	Base	Base	Base			
in	lb	lb	lb	lb	lb	lb	lb		
10	10	SN01	0.411	–	–	2.280	0.069	1.028	0.061
		SN02	0.411	–	–	2.280	0.069	1.028	0.061
		SN05	0.411	–	–	2.280	0.069	1.028	0.061
		BNM05	0.607	–	–	2.280	0.087	1.028	0.061
15	24	SN01	1.079	4.230	7.761	5.771	0.126	2.297	0.095
		SN02	1.079	4.230	7.761	5.771	0.126	2.297	0.095
		SN05	1.079	4.230	7.761	5.771	0.126	2.297	0.095
		BNM05	1.170	4.230	7.761	5.771	0.159	2.297	0.095
		BNM10	1.170	4.230	7.761	5.771	0.159	2.297	0.095
		BZ10	1.170	4.230	7.761	5.771	0.159	2.297	0.095
20	24	BNM05	7.575	23 FRM	23 FRM	7.552	0.325	6.455	0.256
		BNM10	7.575	5.610	9.030	7.552	0.325	6.455	0.256
		BNM20	7.575	34 FRM	34 FRM	7.552	0.325	6.455	0.256
		BZ10	7.575	6.050	9.448	7.552	0.325	6.455	0.256

SPECIFICATIONS (metric measurement)

ERD SIZE*	MAXIMUM STROKE**	SCREW CODE	WEIGHT					WEIGHT (GD2 adder)	
			LMI (AL)	RP (AL)	RP (SS)	(SS2 adder)	Per 25mm	Base	Per Inch
			Base	Base	Base	Base			
mm	kg	kg	kg	kg	kg	kg	kg		
10	254.0	SN01	0.186	–	–	1.034	0.031	0.466	0.028
		SN02	0.186	–	–	1.034	0.031	0.466	0.028
		SN05	0.186	–	–	1.034	0.031	0.466	0.028
		BNM05	0.275	–	–	1.034	0.039	0.466	0.028
15	609.6	SN01	0.489	1.919	3.520	2.618	0.057	1.042	0.043
		SN02	0.489	1.919	3.520	2.618	0.057	1.042	0.043
		SN05	0.489	1.919	3.520	2.618	0.057	1.042	0.043
		BNM05	0.531	1.919	3.520	2.618	0.072	1.042	0.043
		BNM10	0.531	1.919	3.520	2.618	0.072	1.042	0.043
		BZ10	0.531	1.919	3.520	2.618	0.072	1.042	0.043
20	609.6	BNM05	3.436	23 FRM	23 FRM	3.426	0.147	2.928	0.116
		BNM10	3.436	2.545	4.096	3.426	0.147	2.928	0.116
		BNM20	3.436	34 FRM	34 FRM	3.426	0.147	2.928	0.116
		BZ10	3.436	2.744	4.286	3.426	0.147	2.928	0.116

*ERD22, ERD25, ERD30 are replaced by the improved design of the RSH22, RSH25, RSH30

**Longer stroke length modification available upon request.

SCREW CODE	DESCRIPTION
BNM	Ball Nut Metric
BZ	Bronze Nut
SN	Solid Nut

ERD – Electric Rod-Style Actuator



SIZE: **ERD10**

PERFORMANCE

CRITICAL SPEED CAPACITY

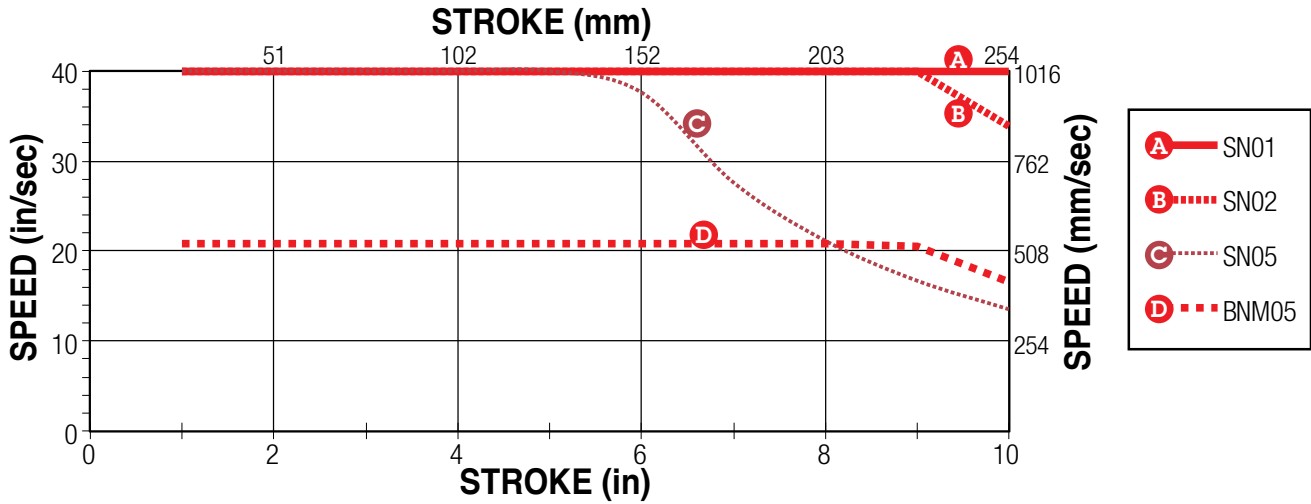

PV LIMITS (ACME NUTS)

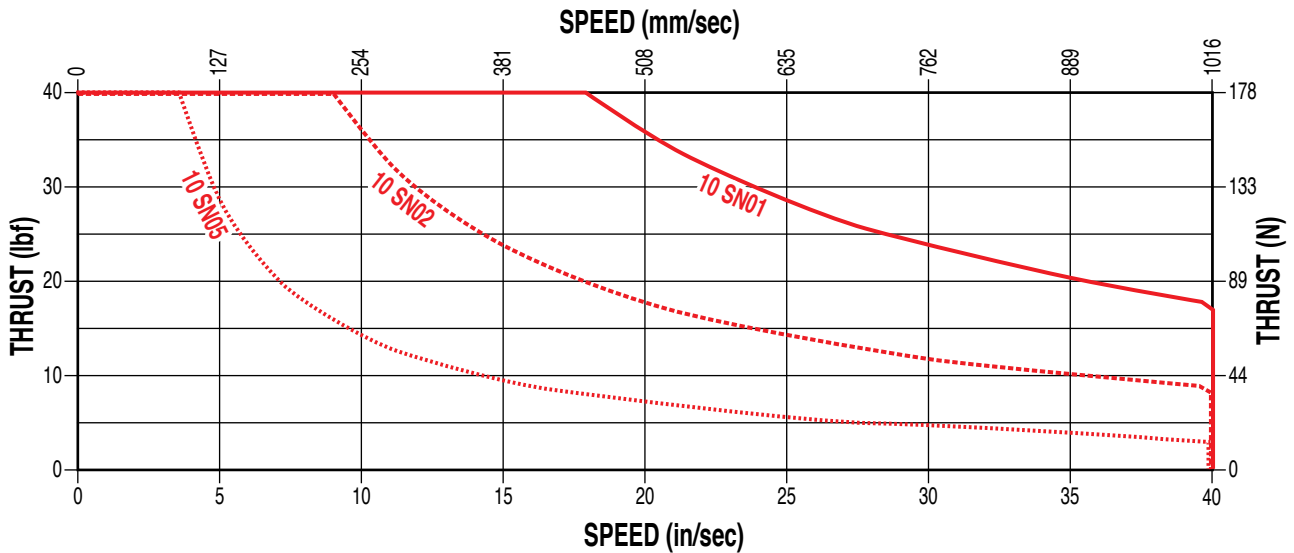

PV LIMITS: Any material which carries a sliding load is limited by heat buildup. The factors that affect heat generation rate in an application are the pressure on the nut in pounds per square inch and the surface velocity in feet per minute. The product of these factors provides a measure of the severity of an application.

(Pressure Velocity of Acme Nut)

$$P \times V \leq 0.1$$

$$\left(\frac{\text{Thrust}}{\text{(Max. Thrust Rating)}} \right) \times \left(\frac{\text{Speed}}{\text{(Max. Speed Rating)}} \right) \leq 0.1$$

SIDE LOAD CONSIDERATIONS

The standard ERD rod-style actuator is not meant to be used in applications where side loading occurs. If side loading exists in the application consider the GD2 guided option.

Loads must be guided and supported. Loads should be aligned with the line of motion of the thrust rod.

Side loading will affect the life of the actuator.

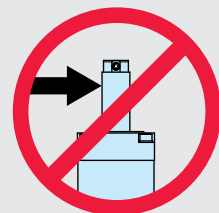

ERD – Electric Rod-Style Actuator



SIZE: **ERD10**

PERFORMANCE

MAXIMUM THRUST vs STROKE

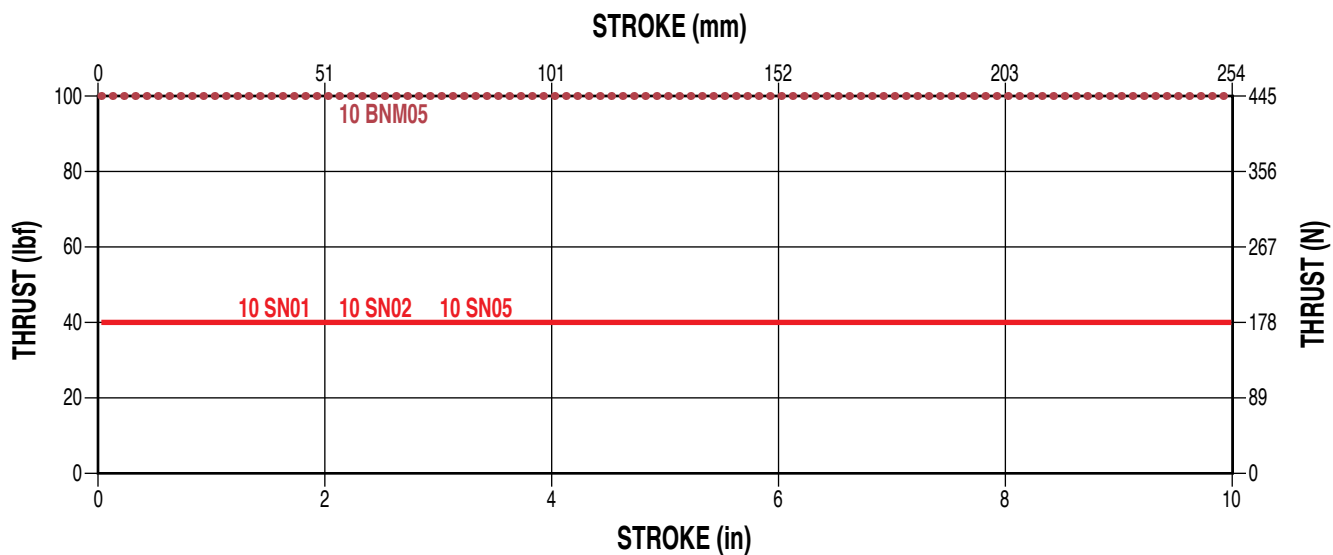

SCREW LIFE (BALL NUTS)

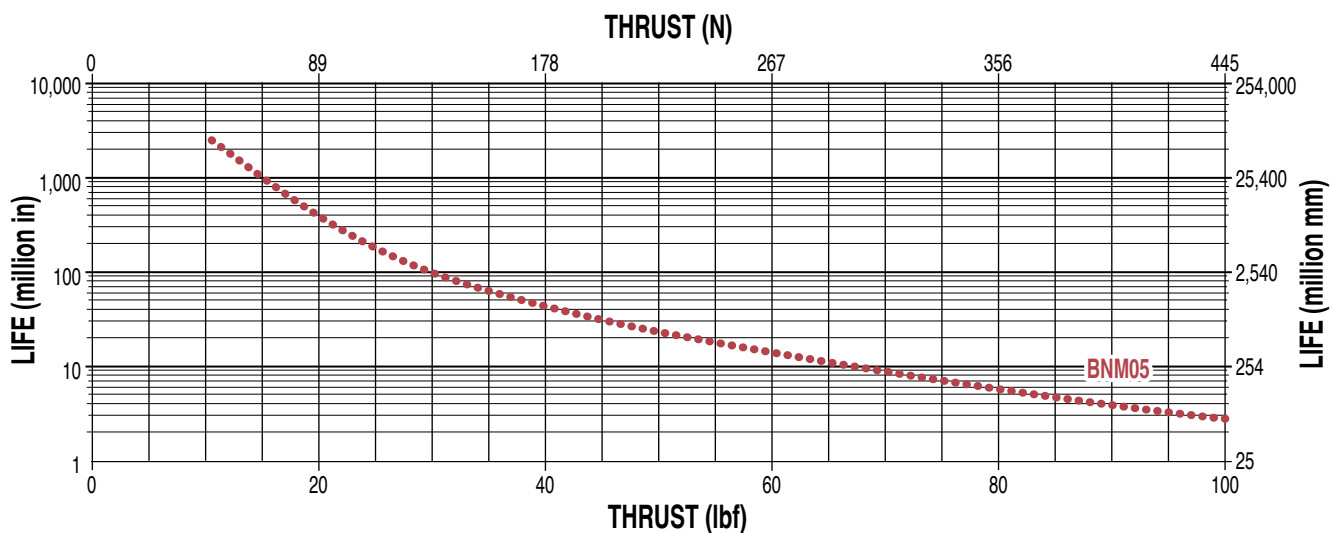

NOTE: The L_{10} expected life of a ball screw linear actuator is expressed as the linear travel distance that 90% of properly maintained ball screw manufactured are expected to meet or exceed. This is not a guarantee and this graph should be used for estimation purposes only.

The underlying formula that defines this value is:

$$L_{10} = \left(\frac{C}{P_e} \right)^3 \cdot \ell =$$

L_{10} Travel life in millions of units (in or mm), where:

C = Dynamic load rating (lbf) or (N)

P_e = Equivalent load (lbf) or (N)

If load is constant across all movements then:

ℓ = actual load = equivalent load
 ℓ = Screw lead (in/rev) (mm/rev)

Use the "Equivalent Load" calculation below, when the load is not constant throughout the entire stroke. In cases where there is only minor variation in loading, use greatest load for life calculations.

$$\text{Where: } P_e = \sqrt[3]{\frac{L_1(P_1)^3 + L_2(P_2)^3 + L_3(P_3)^3 + L_n(P_n)^3}{L}}$$

P_e = Equivalent load (lbf) or (N)

P_n = Each increment at different load (lbf) or (N)

L = Total distanced traveled per cycle (extend + retract stroke)
 $[L = L_1 + L_2 + L_3 + L_n]$

L_n = Each increment of stroke at different load (in) or (mm)

ERD – Electric Rod-Style Actuator



SIZE: **ERD15**

PERFORMANCE

CRITICAL SPEED CAPACITY

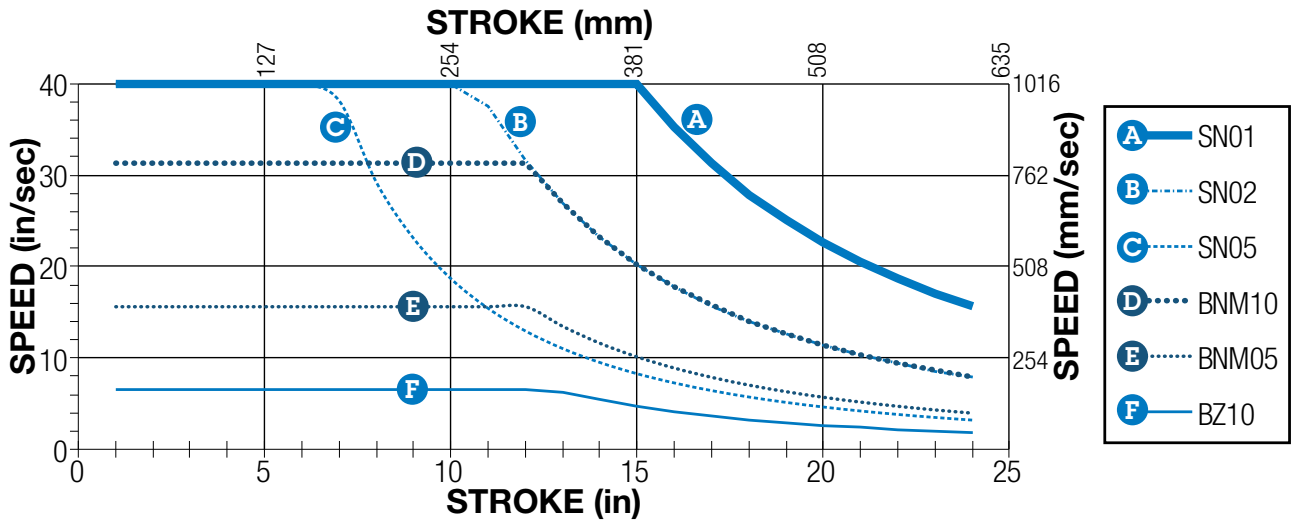

PV LIMITS (ACME NUTS)

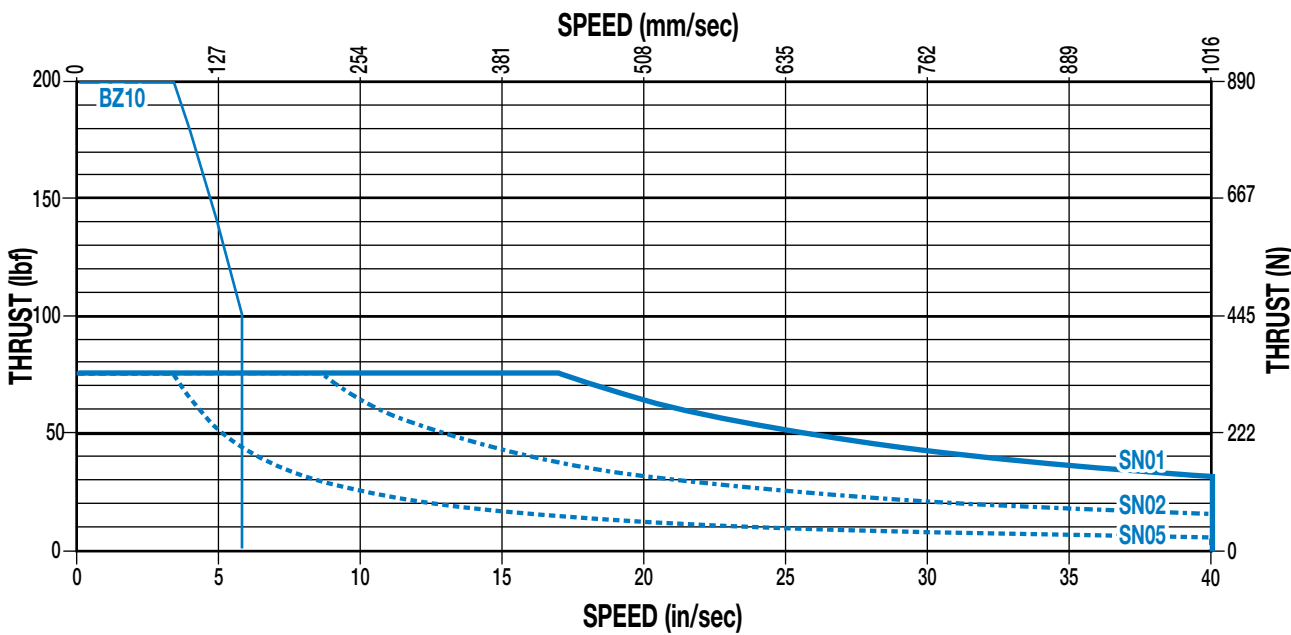

(Pressure Velocity of Acme Nut)

PV LIMITS: Any material which carries a sliding load is limited by heat buildup. The factors that affect heat generation rate in an application are the pressure on the nut in pounds per square inch and the surface velocity in feet per minute. The product of these factors provides a measure of the severity of an application.

$$P \times V \leq 0.1$$

$$\left(\frac{\text{Thrust}}{\text{(Max. Thrust Rating)}} \right) \times \left(\frac{\text{Speed}}{\text{(Max. Speed Rating)}} \right) \leq 0.1$$

ERD – Electric Rod-Style Actuator



SIZE: **ERD15**

PERFORMANCE

MAXIMUM THRUST vs STROKE

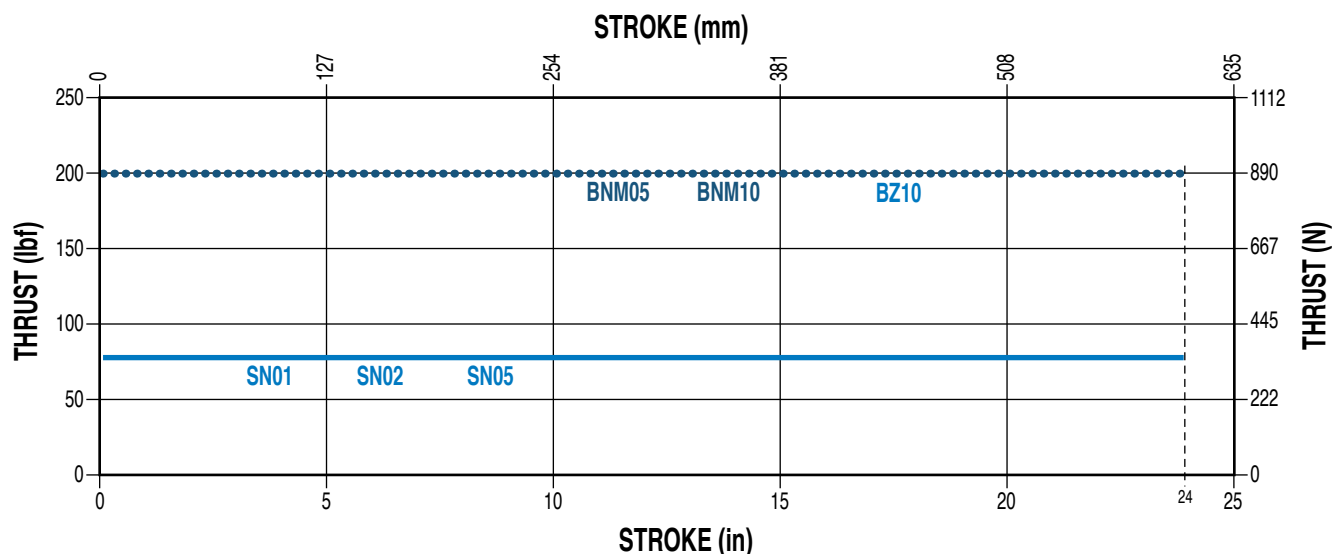

SCREW LIFE (BALL NUTS)

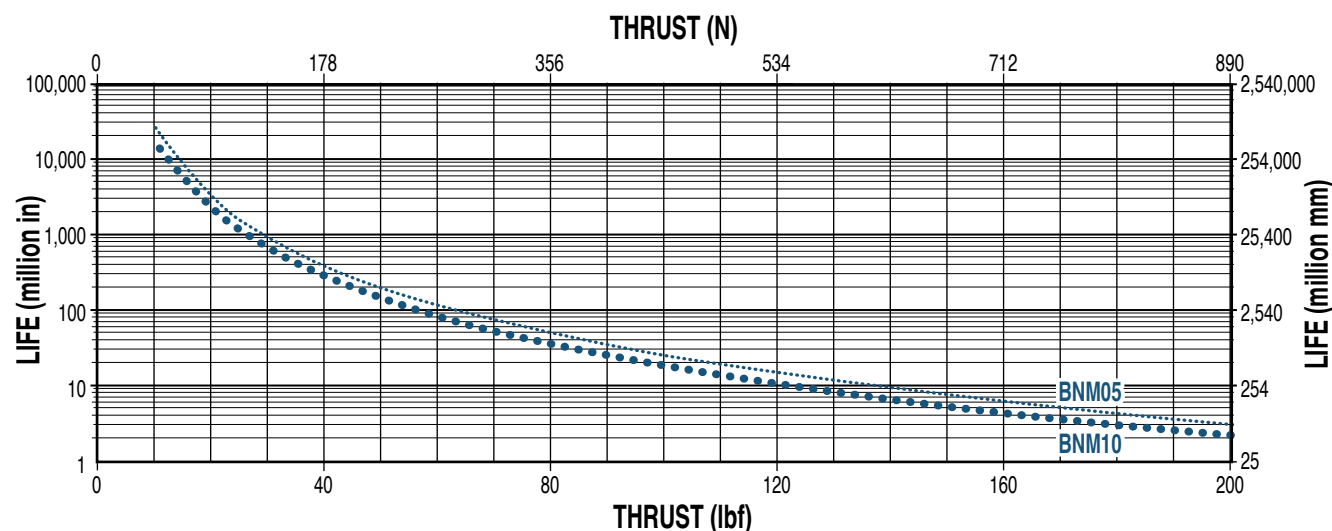

NOTE: The L_{10} expected life of a ball screw linear actuator is expressed as the linear travel distance that 90% of properly maintained ball screw manufactured are expected to meet or exceed. This is not a guarantee and this graph should be used for estimation purposes only.

The underlying formula that defines this value is:

$$L_{10} = \left(\frac{C}{P_e} \right)^3 \cdot \ell =$$

L_{10} Travel life in millions of units (in or mm), where:

C = Dynamic load rating (lbf) or (N)

P_e = Equivalent load (lbf) or (N)

If load is constant across all movements then:

actual load = equivalent load

ℓ = Screw lead (in/rev) (mm/rev)

Use the "Equivalent Load" calculation below, when the load is not constant throughout the entire stroke. In cases where there is only minor variation in loading, use greatest load for life calculations.

$$\text{Where: } P_e = \sqrt[3]{\frac{L_1(P_1)^3 + L_2(P_2)^3 + L_3(P_3)^3 + L_n(P_n)^3}{L}}$$

P_e = Equivalent load (lbf) or (N)

P_n = Each increment at different load (lbf) or (N)

L = Total distanced traveled per cycle (extend + retract stroke)
 $[L = L_1 + L_2 + L_3 + L_n]$

L_n = Each increment of stroke at different load (in) or (mm)

ERD – Electric Rod-Style Actuator



SIZE: **ERD20**

PERFORMANCE

CRITICAL SPEED CAPACITY

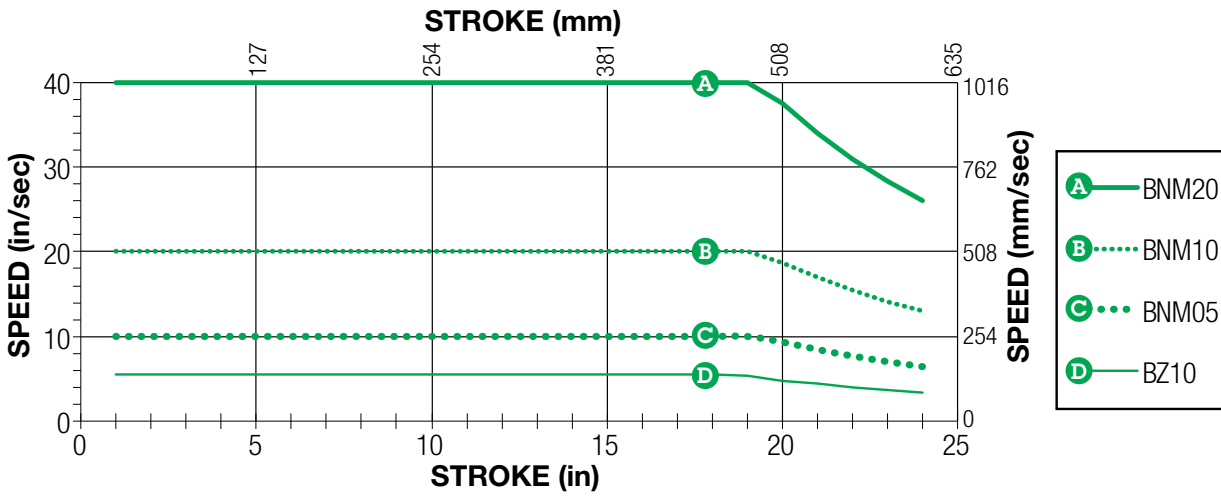

MAXIMUM THRUST vs STROKE

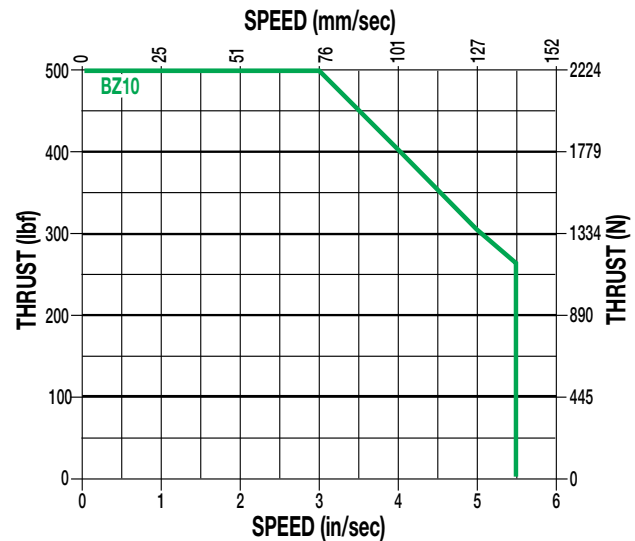
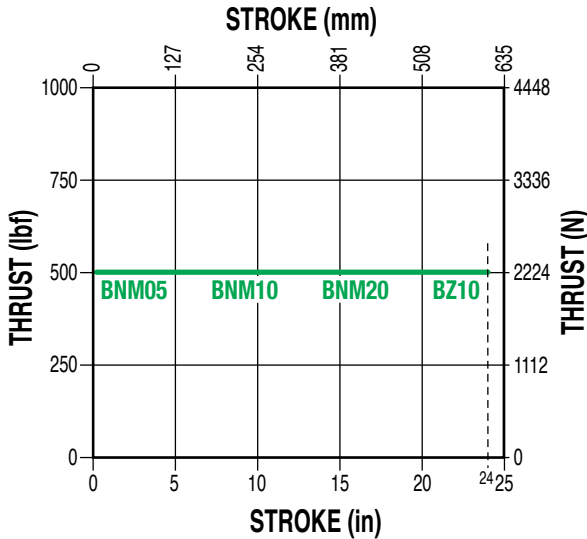

SCREW LIFE

NOTE: See L_{10} expected life calculation on page ERD_12

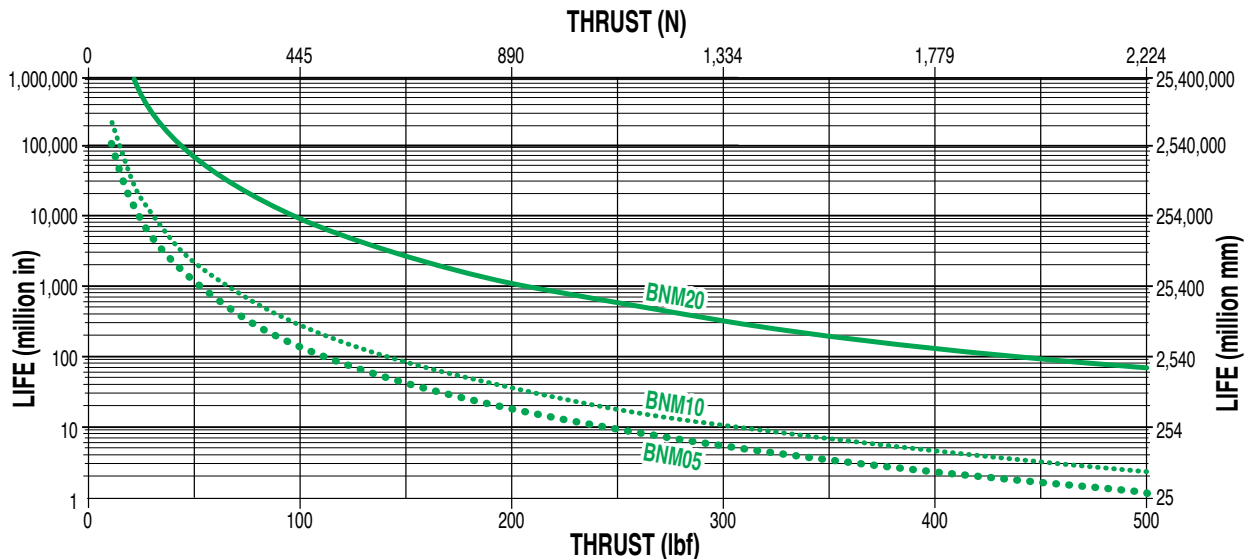

ERD – Electric Rod-Style Actuator

sizeit.tolomatic.com
for fast, accurate
actuator selection

OPTION: **GD2 – GUIDED ERD**

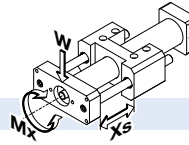

LOAD VS EXTENDED LENGTH

10, 15

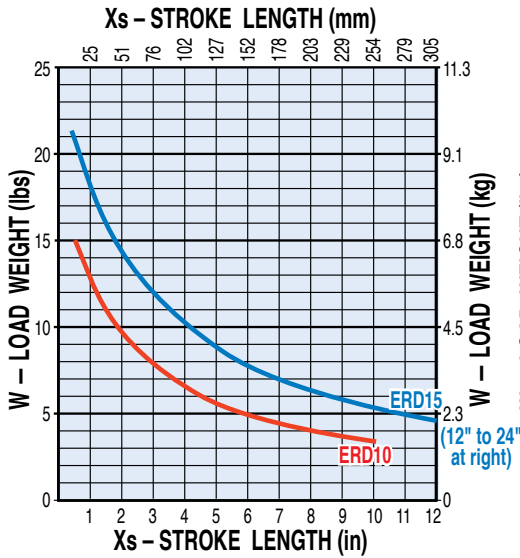

15, 20

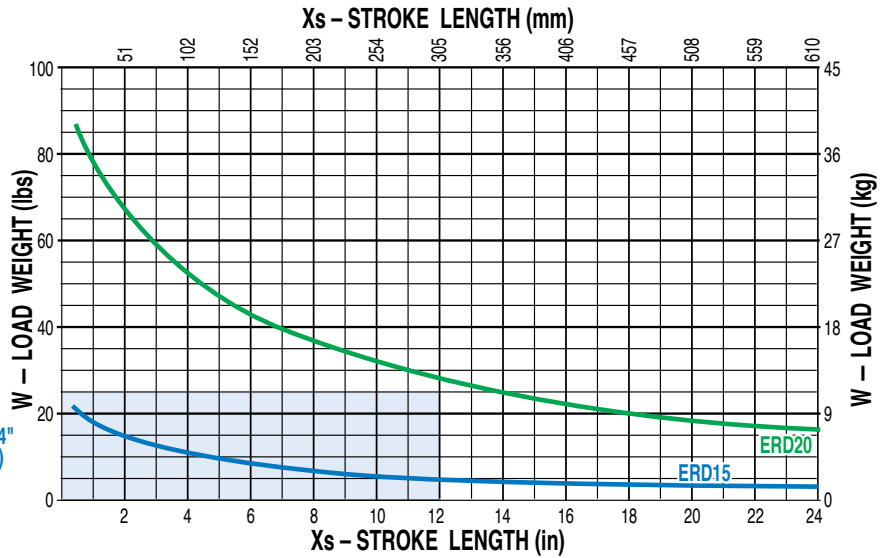

BENDING MOMENTS

10, 15

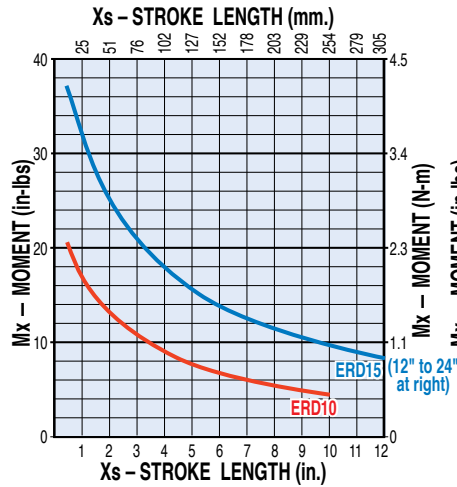

15, 20

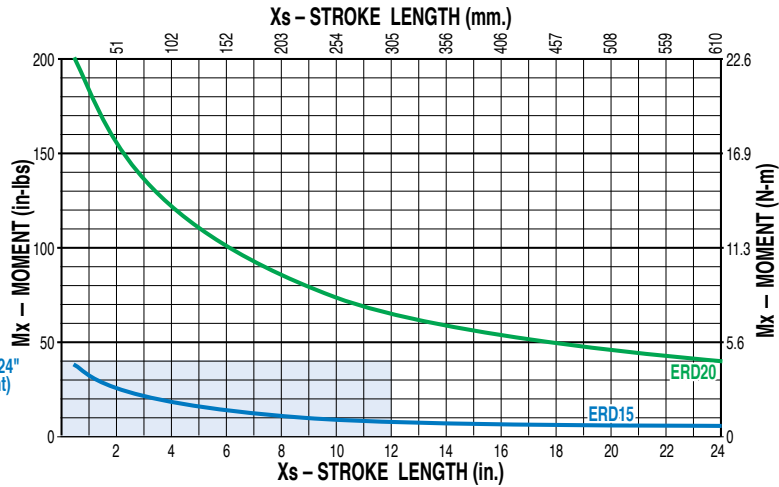

USE THE TOLOMATIC SIZING AND SELECTION SOFTWARE AVAILABLE ON-LINE AT www.tolomatic.com OR... CALL TOLOMATIC AT 1-800-328-2174. We will provide any assistance needed to determine the proper actuator for the job.

ERD – Electric Rod-Style Actuator



OPTION: **GD2 – GUIDED ERD**

PERFORMANCE

GUIDE ROD DEFLECTION

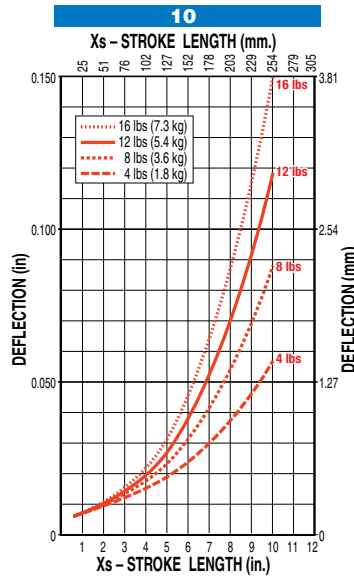

NOTE: Deflection is measured at the tooling plate. Excessive deflection may impact actuator life. Contact Tolomatic for assistance

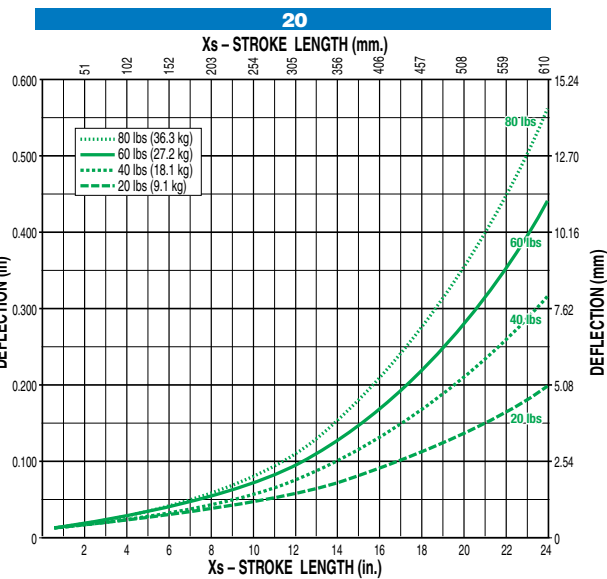
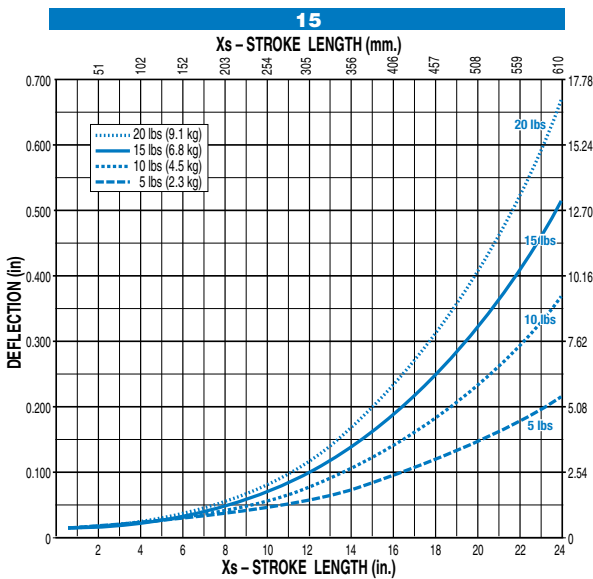
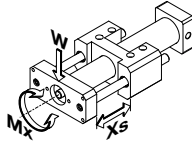

What is an IP Rating?

The IP Code (or Ingress Protection Rating) consists of the letters IP followed by two digits and an optional letter. As defined in international standard IEC 60529, it classifies the degrees of protection provided against the intrusion of solid objects (including body parts like hands and fingers), dust, accidental contact, and water in electrical enclosures.

The IP69K test specifies a spray nozzle that is fed with 80°C water at 8–10MPa (80–100bar) and a flow rate of 14–16L/min. The nozzle is held 10–5 cm from the tested device at angles of 0°, 30°, 60° and 90° for 30s each. The test device sits on a

SOLIDS, FIRST DIGIT:

4	>1 mm	Most wires, screws, etc.
6	Dust tight	No ingress of dust; complete protection against solid object intrusion

LIQUIDS, SECOND DIGIT (static rating)

0	Not protected	
7	Immersion up to 1 m	Ingress of water in harmful quantity shall not be possible when the enclosure is immersed in water under defined conditions of pressure and time (up to 1 m of submersion).
9K	High pressure, high temp. wash-down	As above, plus ingress of water in harmful quantity shall not be possible when the enclosure is subject to high pressure, high temperature wash-down.

turntable that rotates once every 12s (5rpm).

What Does IP69K mean?

German standard DIN 40050-9 extends the IEC 60529 rating system described above with an IP69K rating for high-pressure, high-temperature wash-down applications.[4] Such enclosures must not only be dust tight (IP6X), but also able to withstand high-pressure and steam cleaning.

The first digit indicates the level of protection that the enclosure provides against access to hazardous parts (e.g., electrical conductors, moving parts) and the ingress of solid foreign objects.

The second digit indicates the level of protection that the enclosure provides against harmful ingress of water.

ERD – Electric Rod-Style Actuator



tolomatic.com/CAD
Download 3D CAD
Always use CAD solid model to determine critical dimensions

SIZE: 10, 15, 20

DIMENSIONS

ACTUATOR

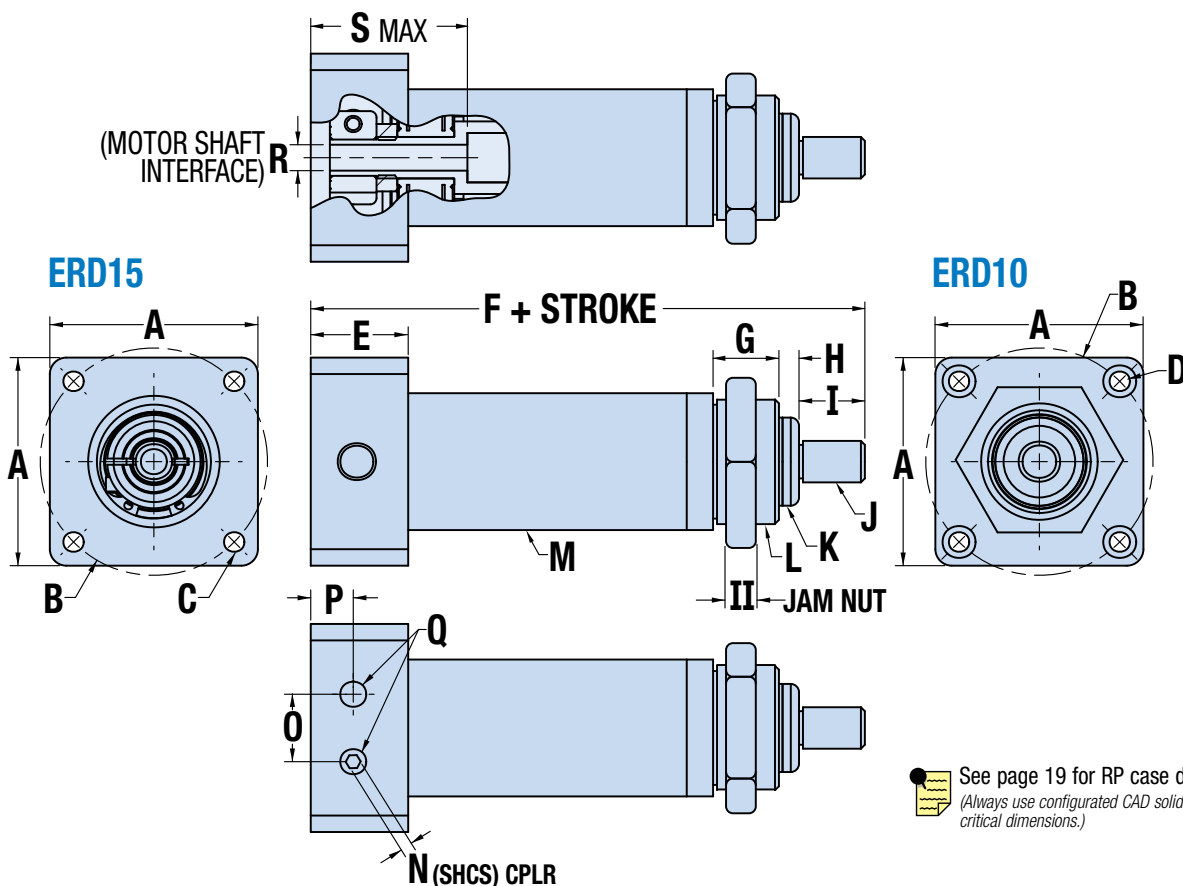

See page 19 for RP case dimensions.
(Always use configured CAD solid model for critical dimensions.)

	ERD10	ERD15	ERD20
A	40.13	56.39*	*
B	Ø43.82	Ø66.68*	*
C	-	M4 x 0.7*	*
D	Ø3.91	-	*
E	18.80	21.59*	*
F	106.7	137.2*	*
G	12.70	15.24	18.75
H	3.89	3.89	3.89
I	12.70	19.05	19.05
J**	M8 x 1.25	M12 x 1.75	M16 x 2.0
K	Ø17.42	Ø26.40	Ø33.60

	ERD10	ERD15	ERD20
L	M24 x 1.5	M34 x 1.5	M44 x 1.5
II	6.00	8.00	8.00
M	Ø26.42	Ø41.61	Ø52.20
N	2.50	2.50*	*
O	13.00	13.00	23.37
P	8.20	7.57*	*
Q	(2) M6 x 1.0 1.0 ± 7.9	(2) M6 x 1.0 ± 12.7	(2) M6 x 1.0 ± 12.7
R	Ø5.00	Ø6.35*	*
S	27.94	31.75*	*

Dimensions in millimeters

	ERD10	ERD15	ERD20
A	1.580	2.220*	*
B	Ø1.725	Ø2.625*	*
C	-	M4 x 0.7*	*
D	Ø.154	-	*
E	0.740	0.850*	*
F	4.20	5.40*	*
G	0.500	0.600	0.750
H	0.153	0.153	0.153
I	0.500	0.750	0.750
J**	M8 x 1.25	M12 x 1.75	M16 x 2.0
K	Ø.686	Ø1.041	Ø1.323

	ERD10	ERD15	ERD20
L	M24 x 1.5	M34 x 1.5	M44 x 1.5
II	0.236	0.315	0.315
M	Ø1.040	Ø1.638	Ø2.051
N	0.098	0.098*	*
O	0.512	0.512	0.920
P	0.323	0.298*	*
Q	(2) M6 x 1.0 1.0 ± .31	(2) M6 x 1.0 ± .50	(2) M6 x 1.0 ± .50
R	Ø.197	Ø.250*	*
S	1.100	1.250*	*

Dimensions in inches



sizeit.tolomatic.com
for fast, accurate
actuator selection



tolomatic.com/ask
Technical support
before and after
purchase

* This dimension is determined by motor choice.
** Note: If ordering as a replacement actuator for use with rod end options, order Code RA1 to receive M10x1.25 rod end thread on the ERD15
Note: If ordering as a replacement actuator for use with rod end options, order Code RA1 to receive M16x1.5 rod end thread on the ERD20

ERD – Electric Rod-Style Actuator



tolomatic.com/CAD
 Download 3D CAD
 Always use CAD solid model to determine critical dimensions

SIZE: 10, 15, 20

DIMENSIONS

IP67 - IP69K OPTION DIMENSIONS

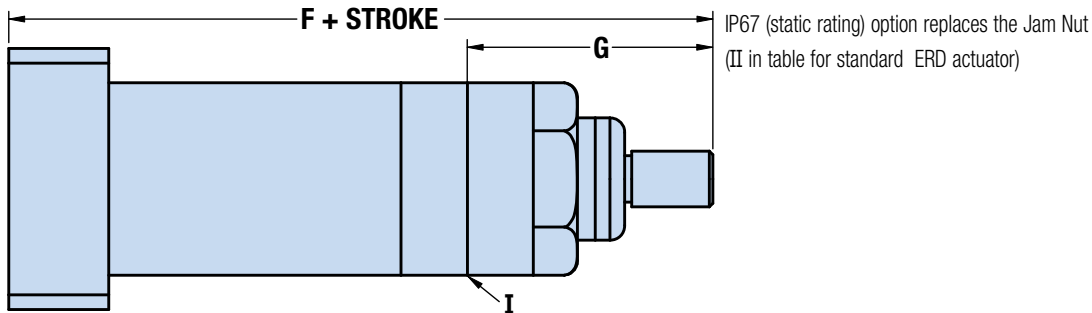

IP67 OPTION

	ERD10	ERD15	ERD20
F	121.8	152.4*	204.8*
G	44.17	53.0	72.5
I	Surface for mounting options		

IP67 OPTION

	ERD10	ERD15	ERD20
F	4.79	6.00*	8.06*
G	1.739	2.09	2.85
I	Surface for mounting options		

IP69K OPTION

	ERD10	ERD15	ERD20
F	128.1	164.8	204.8*
G	50.52	65.7	72.5
I	Surface for mounting options		

IP69K OPTION

	ERD10	ERD15	ERD20
F	5.04	6.49	8.06*
G	1.989	2.59	2.85
I	Surface for mounting options		

Dimensions in millimeters

Dimensions in inches



*Dimension shown is with Tolomatic AMS1xx motor hardware YMH option will determine this dimension.

sizeit.tolomatic.com
 for fast, accurate actuator selection

FFG - FRONT FLANGE*

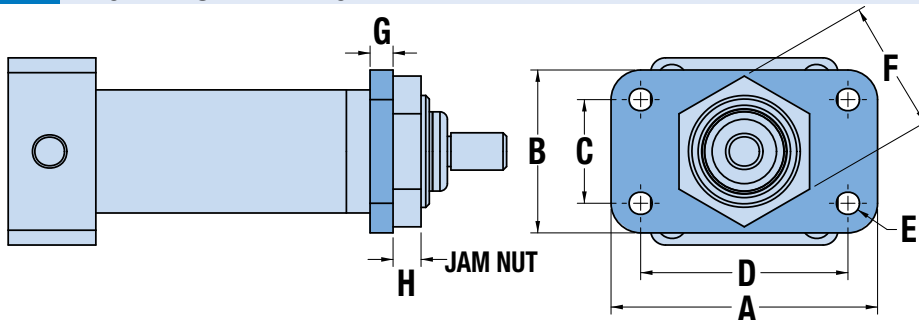

	ERD10	ERD15	ERD20
A	57.15	63.50	88.90
B	34.93	44.45	57.15
C	22.23	31.75	44.45
D	44.45	50.80	76.20
E	Ø4.93	Ø5.61	Ø7.14
F	28.00	40.00	48.08
G	4.93	4.93	4.93
H	6.00	8.00	8.00

Dimensions in millimeters

	ERD10	ERD15	ERD20
A	2.250	2.500	3.500
B	1.375	1.750	2.250
C	0.875	1.250	1.750
D	1.750	2.000	3.000
E	Ø0.194	Ø0.221	Ø0.281
F	1.102	1.575	1.890
G	0.194	0.194	0.194
H	0.236	0.315	0.315

Dimensions in inches

tolomatic.com/ask
 Technical support before and after purchase



*The FFG option for the ERD Sizes 10, 15, and 20 comes loosely tightened from Tolomatic to allow for ease of installation in the field. The Jam Nut must be tightened after ERD installation according to the procedure in ERD Parts Sheet 2190-4001

ERD – Electric Rod-Style Actuator



tolomatic.com/CAD
Download 3D CAD
Always use CAD solid model to determine critical dimensions

SIZE: 10, 15, 20

DIMENSIONS

SRE SPHERICAL ROD END

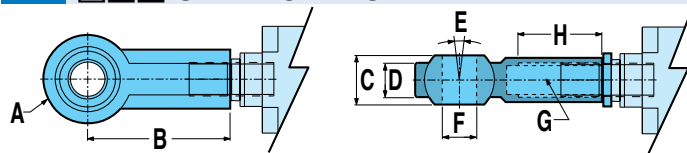

Size	A Ø	B	C	D	E	F Ø	G	H
10	22.3	36.0	12.0	8.8	10°	8.0	M8x1.25	17.0
15	28.0	43.0	14.0	10.5	10°	10.0	M10x1.25	20.0
20	42.0	64.0	21.0	15.0	10°	16.0	M16x1.5	28.0

Dimensions in millimeters

Allows for slight misalignment between the load and the actuator (radial and angular).
Uses an industry-standard bearing.

Size	A Ø	B	C	D	E	F Ø	G	H
10	0.88	1.42	0.47	0.34	10°	0.31	M8x1.25	0.67
15	1.10	1.69	0.55	0.41	10°	0.39	M10x1.25	0.79
20	1.65	2.52	0.83	0.59	10°	0.63	M16x1.5	1.10

Dimensions in inches

CLV CLEVIS ROD END

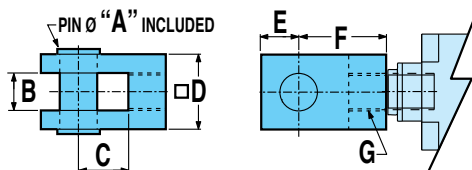

Used with the externally threaded rod end when the actuator has to compensate for misalignment or pivot about an axis.

Size	A Ø	B	C	D	E	F	G
10	8.0	8.0	16.0	16.0	10.0	32.0	M8x1.25
15	10.0	10.0	20.0	20.0	12.0	40.0	M10x1.25
20	16.0	16.0	32.0	32.0	19.0	64.0	M16x1.5

Dimensions in millimeters

* Note: ERD15 rod end options use M10 X1.25 thread, not the standard M12 X 1.75 rod end thread. When ordering an attachment with the actuator the actuator will come with M10x1.25 thread.
Note: ERD20 rod end options use M16 X1.5 thread, not the standard M16 X 2.0 rod end thread. When ordering an attachment with the actuator the actuator will come with M16x1.5 thread.

Size	A Ø	B	C	D	E	F	G
10	0.32	0.32	0.63	0.63	0.39	1.26	M8x1.25
15	0.39	0.39	0.79	0.79	0.47	1.57	M10x1.25
20	0.63	0.63	1.26	1.26	0.75	2.52	M16x1.5

Dimensions in inches

ALC ALIGNMENT COUPLER

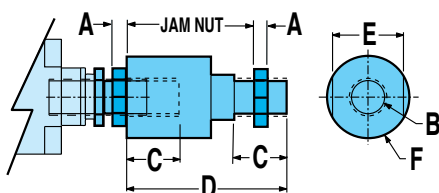

Used in combination with the externally threaded rod end to provide smooth motion and extends actuator life by preventing binding caused by angular or axial misalignment. Not available for use with clevis or trunnion mounts, as they must be rigidly mounted.

Size	A	B	C	D	E	F
15	6.0	M10x1.25	20.0	73.0	30.0	32.0
20	8.0	M16x1.5	32.0	108.0	41.0	45.0

Dimensions in millimeters

Size	A	B	C	D	E	F
15	0.24	M10x1.25	0.79	2.87	1.18	1.26
20	0.31	M16x1.5	1.26	4.25	1.61	1.77

Dimensions in inches

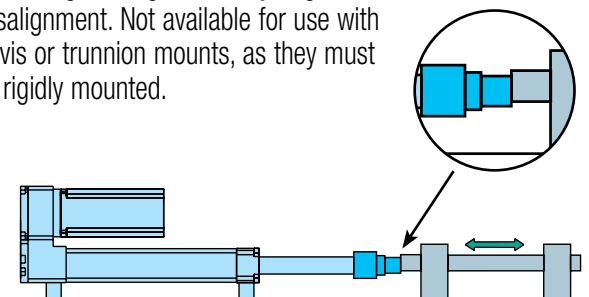

Note: ERD15 rod end options use M10 X1.25 thread, not the standard M12 X 1.75 rod end thread. When ordering an attachment with the actuator the actuator will come with M10x1.25 thread.

Note: ERD20 rod end options use M16 X1.5 thread, not the standard M16 X 2.0 rod end thread. When ordering an attachment with the actuator the actuator will come with M16x1.5 thread.

ERD – Electric Rod-Style Actuator

tolomatic.com/CAD
 Download 3D CAD
Always use CAD solid model to determine critical dimensions

SIZE: 10, 15, 20

DIMENSIONS

FM2 - FOOT MOUNT

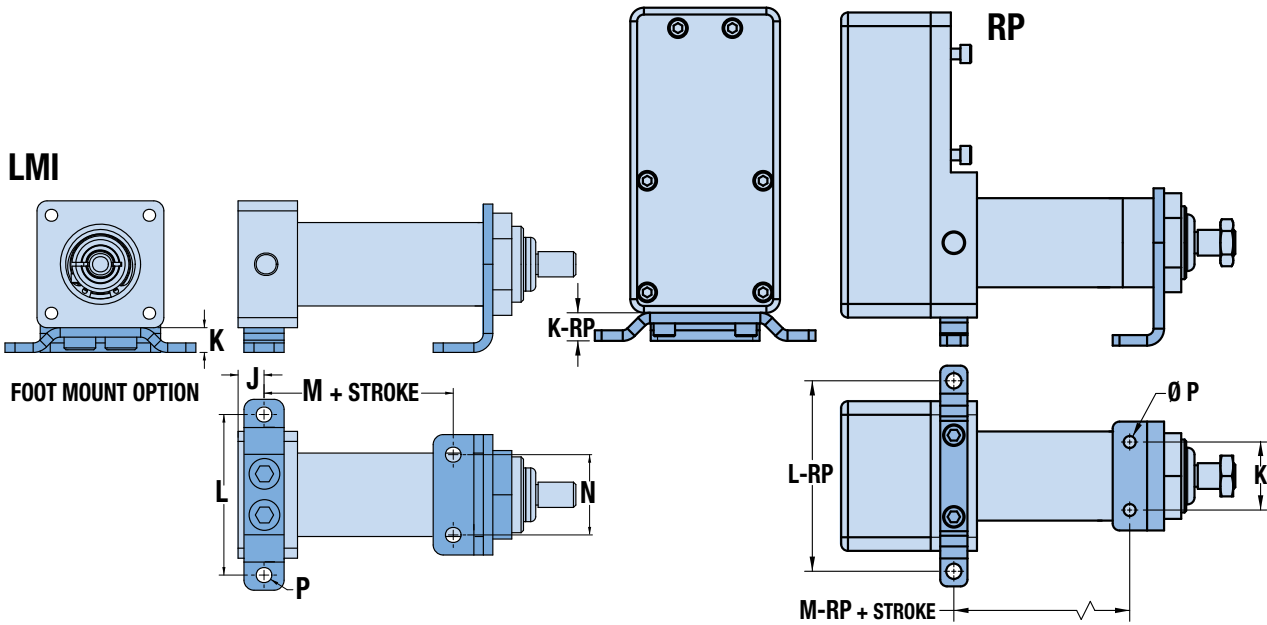

	ERD10		ERD15		ERD20	
	ERD10	ERD15	ERD15	BNM20	ERD20	BNM20
J	8.20	7.57	—	—	—	—
K	7.82	10.31	14.46	—	—	—
L	50.80	66.04	82.55	—	—	—
M	59.87	80.39	81.28	109.86	—	—
N	25.4	31.75	31.75	—	—	—
P	Ø4.93	Ø5.61	Ø7.14	—	—	—
K-RP	—	13.11	12.70	—	—	—
L-RP	—	88.90	93.35	—	—	—
M-RP	—	77.15	66.95	95.53	—	—

Dimensions in millimeters

	ERD10		ERD15		ERD20	
	ERD10	ERD15	ERD15	BNM20	ERD20	BNM20
J	0.323	0.298	—	—	—	—
K	0.308	0.406	0.569	—	—	—
L	2.00	2.600	3.250	—	—	—
M	2.357	3.165	3.200	4.325	—	—
N	1.00	1.250	1.25	—	—	—
P	Ø.194	Ø.221	Ø.281	—	—	—
K-RP	—	0.516	0.500	—	—	—
L-RP	—	3.500	3.675	—	—	—
M-RP	—	3.038	2.636	3.761	—	—

Dimensions in inches

sizeit.tolomatic.com
 for fast, accurate
 actuator selection

sizeit.tolomatic.com for fast, accurate actuator selection
 or call Tolomatic (1-800-328-2174) with application information. We will provide any assistance needed to determine the proper actuator.

tolomatic.com/ask
 Technical support
 before and after
 purchase

ERD – Electric Rod-Style Actuator



tolomatic.com/CAD
Download 3D CAD
Always use CAD solid model to determine critical dimensions

SIZE: 10, 15, 20

DIMENSIONS

TRM/TRR - TRUNNION MOUNT

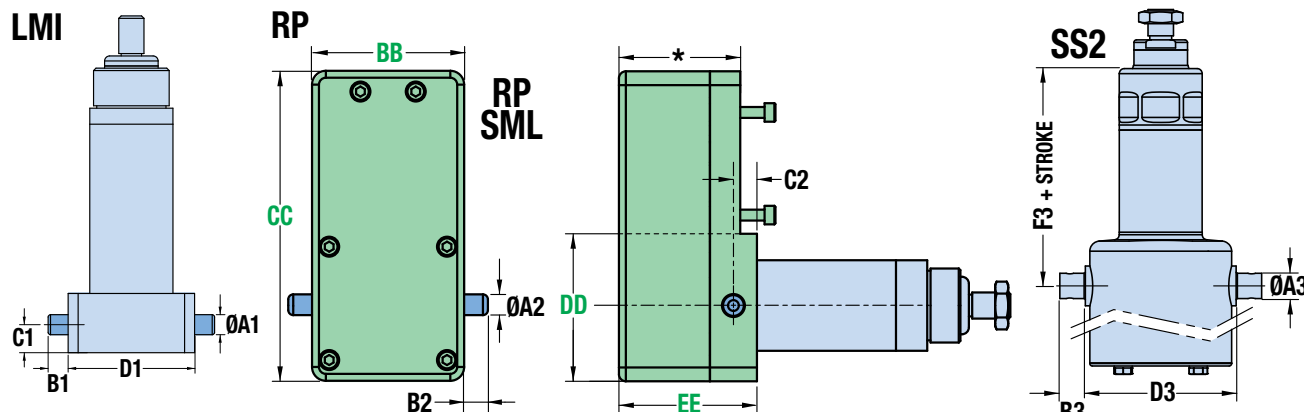

*Dimension is variable dependent on YMH motor code.

PCD - REAR CLEVIS (RP)

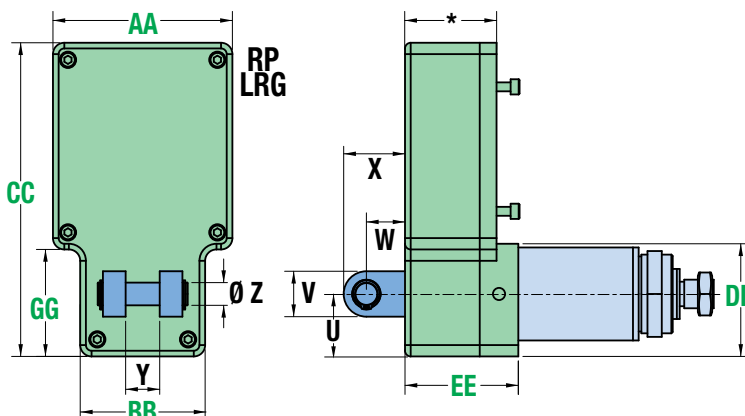

TRM	ERD10	ERD15	ERD20
ØA1	Ø8.000 +0.015 -0.006	Ø12.000 +0.005 0.000	Ø15.997 Ø15.982
B1	6.4	10.9	19.0
C1	9.9	10.8	25.1
D1	40.1	56.4	60.0

Dimensions in millimeters

TRR	ERD10	ERD15	ERD20
ØA1	0.2500 +0.0002 0.0000	0.375 +0.0007 +0.0003	0.6245 0.6240
B1	0.25	0.43	0.75
C1	0.39	0.43	0.99
D1	1.58	2.22	2.36

Dimensions in inches

TRM	ERD15	ERD20
ØA2	Ø12.000 +0.018 -0.007	Ø16.00 / Ø15.98
ØA3	Ø11.987 / Ø11.975	Ø15.98 / Ø15.95
B2	10.9	19.1
B3	12.7	16.0
C2	10.8	10.8
D3	93.4	94.7
F3	123.3	136.4
F3 (BNM20)	-	165.1

Dimensions in millimeters

TRR	ERD15	ERD20
ØA2	0.3750 +0.0002 -0.0000	0.6245 / 0.6240
ØA3	0.4719 / 0.4714	0.629 / 0.628
B2	0.43	0.75
B3	0.50	0.63
C2	0.43	0.42
D3	3.68	3.73
F3	4.85	5.37
F3 (BNM20)	-	6.50

Dimensions in inches

	15		20	
	PCD1	PCD2	PCD1	PCD2
U SML	34.93	34.93	34.93	34.93
U LRG	--	--	34.93	34.93
V	25.40	24.00	25.40	24.00
W	21.56	21.56	21.59	21.59
X	34.26	33.55	34.29	33.58
Y	19.05	27.99	19.05	27.99
Z	12.687 / 12.675	11.99 / 11.97	12.687 / 12.675	11.99 / 11.97
AA SML	69.85	69.85	69.85	69.85
AA LRG	--	--	100.33	100.33
BB	--	--	69.85	69.85
CC SML	142.37	142.37	142.37	142.37
CC LRG	--	--	175.39	175.39
DD SML	58.72	58.72	62.36	62.36
DD LRG	--	--	62.99	62.99
EE	63.40	63.40	63.40	63.40
GG	--	--	59.82	59.82

Dimensions in millimeters

	15		20	
	PCD1	PCD2	PCD1	PCD2
U SML	1.375	1.375	1.375	1.375
U LRG	--	--	1.375	1.375
V	1.000	0.945	1.000	0.945
W	0.849	0.849	0.850	0.850
X	1.349	1.321	1.350	1.322
Y	0.750	1.102	0.750	1.102
Z	.4995 / .4990	.4719 / .4714	.4995 / .4990	.4719 / .4714
AA SML	2.750	2.750	2.750	2.750
AA LRG	--	--	3.950	3.950
BB	--	--	2.750	2.750
CC SML	5.605	5.605	5.605	5.605
CC LRG	--	--	6.905	6.905
DD SML	2.312	2.312	2.455	2.455
DD LRG	--	--	2.480	2.480
EE	2.496	2.496	2.496	2.496
GG	--	--	2.355	2.355

Dimensions in inches

ERD – Electric Rod-Style Actuator

tolomatic.com/CAD
 Download 3D CAD
 Always use CAD solid model to determine critical dimensions

SIZE: 10, 15, 20

DIMENSIONS

SS2 – STAINLESS-STEEL BODY WITH PROTECTIVE MOTOR COVER AND IP69K UPGRADE

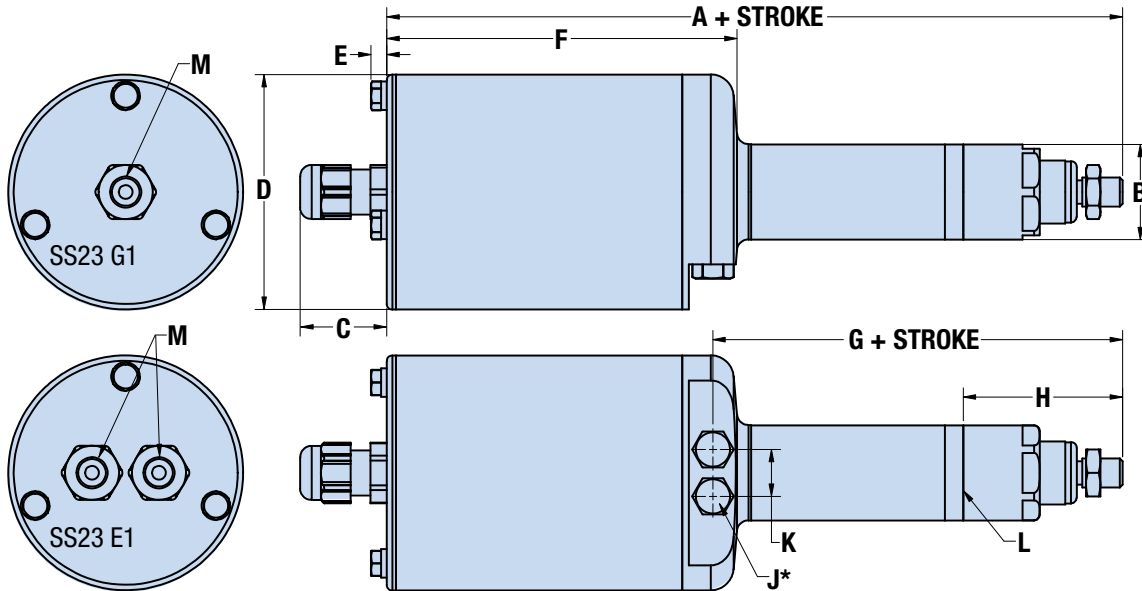

	ERD10	ERD15	ERD20	
				BNM20
A	204.0	282.70	311.4	339.98
B	26.42	41.61	52.10	
C	24.00	24.00	24.00	
D	65.10	89.00	89.00	
E	4.39	5.27	5.27	
F	100.99	134.98	171.64	
G	113.56	143.76	164.80	193.37
H	44.17	53.04	72.48	
J*	M6 x 1.0	M6 x 1.0	M6 x 1.0	
K	13.00	13.00	23.37	
L	Surface for mounting options			

Dimensions in millimeters

	ERD10	ERD15	ERD20	
				BNM20
A	8.03	11.130	12.26	13.385
B	1.040	1.638	2.051	
C	0.945	0.945	0.945	
D	2.563	3.504	3.504	
E	0.173	0.207	0.207	
F	3.976	5.314	6.758	
G	4.471	5.660	6.488	7.613
H	1.739	2.088	2.853	
J*	M6 x 1.0	M6 x 1.0	M6 x 1.0	
K	0.512	0.512	0.920	
L	Surface for mounting options			

Dimensions in inches

M	Code	Encoder Code	Available cable exit options:
	SS21	G1, E1	no cord grips 1/2" NPT tapped hole
	SS22	G1, E1	no cord grips M20 x 1.5 tapped hole
	SS23	G1	1 cord grip (motor, no encoder)
	E1	2 cord grips (motor, with encoder)	

*Unit ships standard with hex bolts in these tapped holes



sizeit.tolomatic.com

for fast, accurate actuator selection

or call Tolomatic (1-800-328-2174) with application information. We will provide any assistance needed to determine the proper actuator.



ERD – Electric Rod-Style Actuator



tolomatic.com/CAD

Download 3D CAD

Always use CAD solid model to determine critical dimensions

SIZE: 10, 15, 20

DIMENSIONS

GD2 – GUIDED ERD

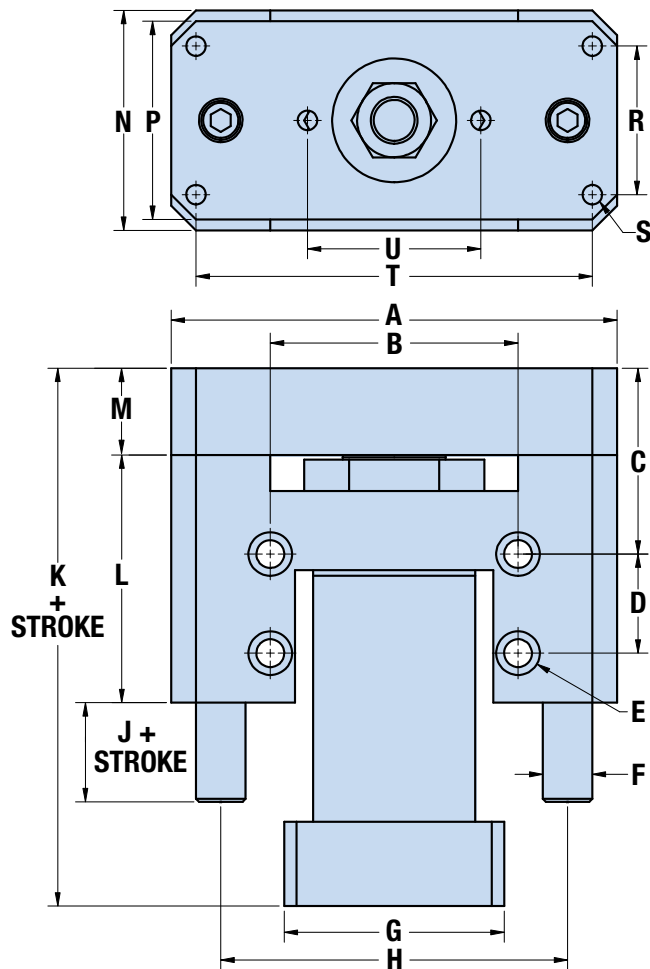

GUIDED ERD WITH IP67 OPTION

ERD STROKE IS REDUCED BY DIMENSION "V"

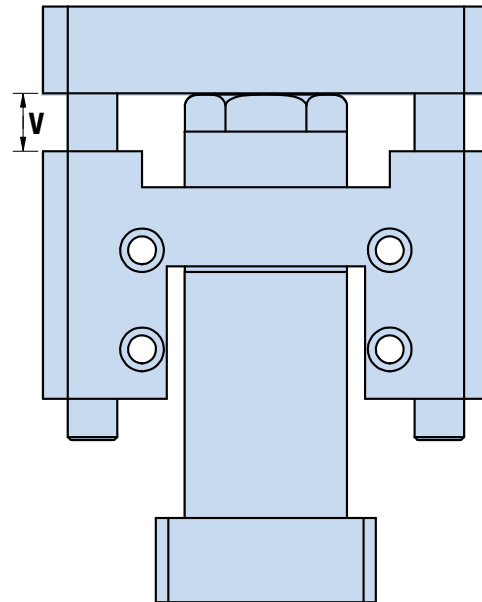

	ERD10	ERD15	ERD20
A	88.90	114.30	149.86
B	50.80	63.50	82.55
C	31.75	47.63	63.50
D	25.40	25.40	50.8
E Ø	5.61	7.14	8.74
F Ø	9.53	12.70	19.05
G	40.13	56.39*	*
H	69.85	88.90	117.48
J	25.40	25.40	38.10
K	107.80	137.87*	*
L	50.80	63.50	127.00
M	15.88	22.23	25.40
N	40.13	56.39	60.96
P	38.10	50.80	58.42
R	25.40	38.10	38.10
S	M5x0.8	M6x1.0	M8x1.25
T	76.20	101.60	127.00
U	34.93	44.45	57.15
V	14.91	14.86	30.47

Dimensions in millimeters

	ERD10	ERD15	ERD20
A	3.500	4.500	5.900
B	2.000	2.500	3.250
C	1.250	1.875	2.500
D	1.000	1.000	2.000
E Ø	0.221	0.281	0.344
F Ø	0.375	0.500	0.750
G	1.580	2.220*	*
H	2.750	3.500	4.625
J	1.000	1.000	1.500
K	4.244	5.428*	*
L	2.000	2.500	5.000
M	0.625	0.875	1.000
N	1.580	2.220	2.400
P	1.500	2.000	2.300
R	1.000	1.500	1.500
S	M5x0.8	M6x1.0	M8x1.25
T	3.000	4.000	5.000
U	1.375	1.750	2.250
V	0.587	0.585	1.200

Dimensions in inches



*This dimension is determined by motor choice.

ERD – Electric Rod-Style Actuator



SIZE: 10, 15

DIMENSIONS

ALTERNATIVE MOTOR DIMENSIONS

MOTOR DIMENSIONS – NEMA MOTOR MOUNT

The ERD 10 & 15 sizes are designed to accommodate NEMA standard stepper and servo motors.

ACTUATOR	SIZE
ERD10	NEMA17
ERD15	NEMA23

The only limiting factors are the motor shaft diameter and length. NEMA standard motors from the companies in the table at right have been found to be compatible with the ERD actuator. (📄 *NOT a complete listing)

ERD Compatible NEMA Motor Suppliers*

Anaheim Automation
Animatics
Applied Motion Products
Automation Direct
Cool Muscle
Electrocraft
Fastech
IMS / Scheider Electric
JVL
LIN Engineering
Nippon Pulse Motor
Omega
Oriental Motor
Parker
Sanyo Denki
+ Others

⚠ When any motor has been selected for use with the ERD actuator it is important to confirm the motor is compatible with the dimensions in the table below.

		ERD10	ERD15	ERD10	ERD15	
MOTOR SHAFT	LENGTH	A	12.7	12.7	0.50	0.50
	MIN.		27.94	31.75	1.100	1.250
MOTOR SHAFT	DIAMETER	B	5.00	6.35	0.197	0.250
	MAX.					
BOLT HOLE	CIRCLE	C	43.82	66.68	1.725	2.625
	SPACING		D	30.99	47.14	1.220
MOTOR PILOT	DIAMETER MAX.	E		24.90	39.37	0.980
	HEIGHT MAX.		F	3.30	3.30	0.130

Dimensions in millimeters

Dimensions in inches

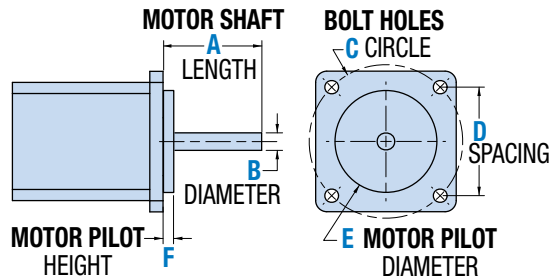

MOTOR CHOICES - YOUR MOTOR HERE

SELECT A COMPLETE SYSTEM FROM TOLOMATIC OR ADD ANY MOTION SYSTEM TO OUR ACTUATORS

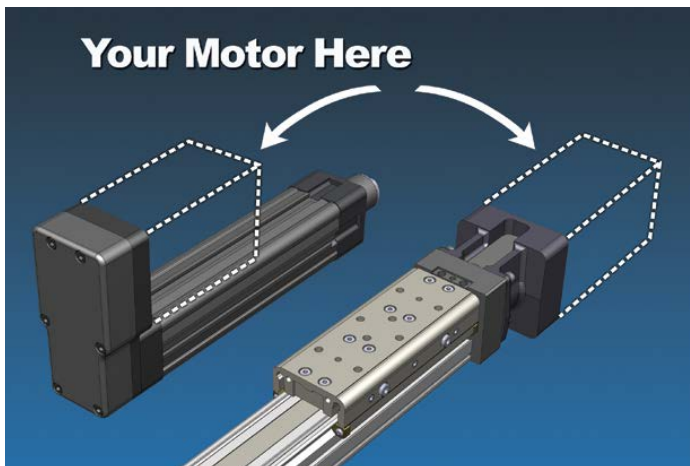

"YOUR MOTOR HERE" MADE-TO-ORDER MOTOR MOUNTS.

- Select a high-performance Tolomatic electric actuator and we'll provide a motor-specific interface for your motor. With our online database, you can select from over 60 motor manufacturers and hundreds of models.

Visit www.tolomatic.com/ymh to find your motor/actuator match!

The ERD 15, 20 sizes utilize Tolomatic's YMH (Your Motor Here) program. See www.tolomatic.com/ymh or consult Tolomatic sales at 1-800-328-2174 for details.

Configure an actuator and a complete motion control system today using Tolomatic's easy-to-use on-line sizing & selection



ERD – Electric Rod-Style Actuator



SWITCHES



ERD actuators have 6 switch options: reed, solid state PNP (sourcing) or solid state NPN (sinking); normally open; with flying leads or quick-disconnect.

Commonly used for end-of-stroke positioning, these switches allow clamp-on installation anywhere along the entire actuator length. The internal magnet, located on the thrust tube, is a standard feature. Switches can be installed in the field at any time.

Switches are used to send digital signals to PLC (programmable logic controller), TTL, CMOS circuit or other controller device. Switches contain reverse polarity protection. Solid state QD cables are shielded; shield should be terminated at flying lead end.

All switches are CE rated, IP67 rated and are RoHS compliant. Switches feature bright red or green LED signal indicators.



	Order Code	Lead	Switching Logic	Power LED	Signal LED	Operating Voltage	**Power Rating (Watts)	Switching Current (mA max.)	Current Consumption	Voltage Drop	Leakage Current	Temp. Range	Shock / Vibration	IP Rating
REED	R Y	5m	SPST Normally Open	—	Red	5 - 240 AC/DC	**10.0	100mA	—	3.0 V max.	—	14 to 158°F	30 G / 9 G	67
	R K	QD*												
SOLID STATE	T Y	5m	PNP (Sourcing) Normally Open	—	Green	5 - 30 VDC	**3.0	200mA	8 mA @ 24V	1.0 V max.	0.01 mA max.	[-10 to 70°C]	50 G / 9 G	67
	T K	QD*												
	K Y	5m	NPN (Sinking) Normally Open	—	Red									
	K K	QD*												

*QD = Quick-disconnect Enclosure classification IEC 529 IP67 (NEMA 6)

CABLES: Robotic grade, oil resistant polyurethane jacket, PVC insulation

⚠️ **WARNING: Do not exceed power rating (Watt = Voltage x Amperage). Permanent damage to sensor will occur.

SWITCH INSTALLATION - FIELD REPLACEMENT INSTRUCTIONS

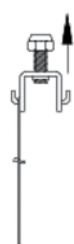

STEP 1:
Loosen screw and nut.



STEP 2:
Place sensor and wrap the band around the ERD cylinder. Position the hook with the nearest hole on the band and mark the hole with a permanent marker.

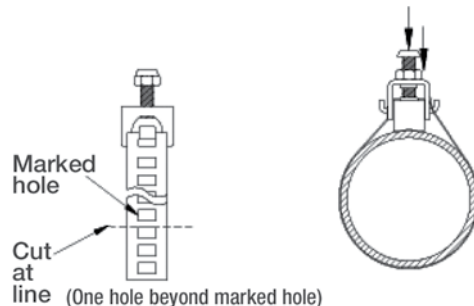

STEP 3:
Remove mounting assembly. Cut the band at the nearest edge of the next hole. (The one that's furthest away from the mounting head.)



STEP 4:
Replace the sensor and mounting assembly. Wrap the band and put the chosen hole on the hook. Position the switch and tighten. Tighten nut for steadying.

ERD – Electric Rod-Style Actuator



SWITCHES

SPECIFICATIONS

WIRING DIAGRAMS

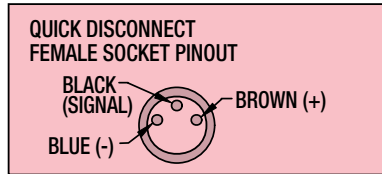
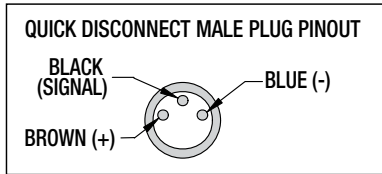
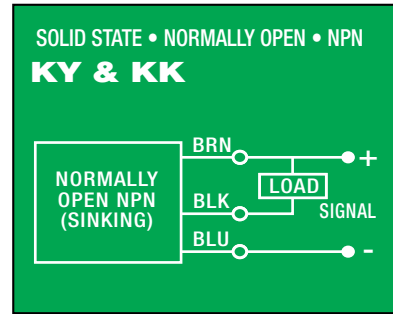
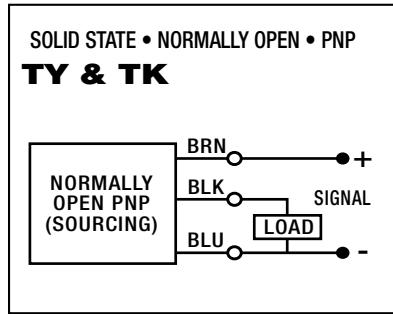
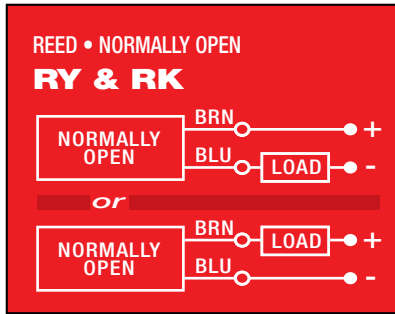

SWITCH DIMENSIONS

Y - direct connect

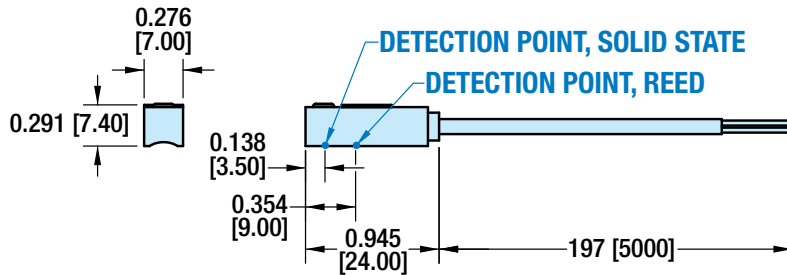

K - QD (Quick-disconnect) switch

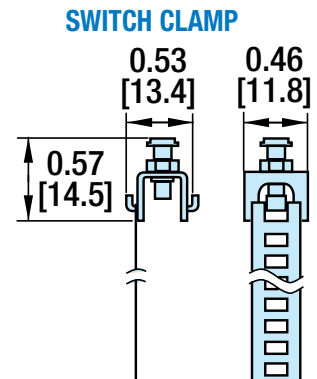
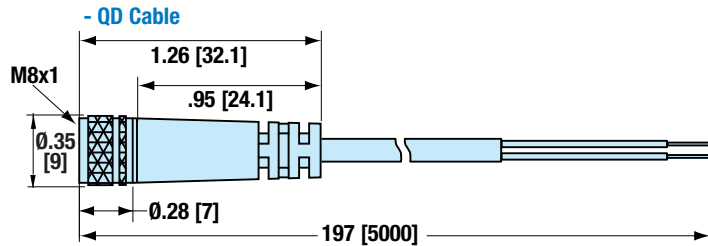

APPLICATION DATA WORKSHEET

Fill in known data. Not all information is required for all applications

ORIENTATION

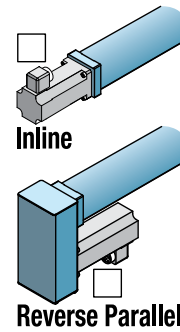
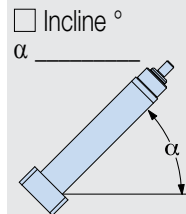
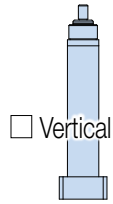
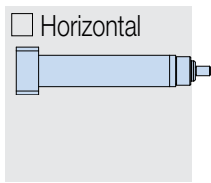

Load supported by actuator OR Load supported by other mechanism

MOVE PROFILE

EXTEND

Move Distance _____

inch (US conventional) millimeters (Metric)

Move Time _____ sec

Max. Speed _____

in/sec mm/sec

Dwell Time After Move _____ sec

RETRACT

Move Distance _____

inch millimeters

Move Time _____ sec

Max. Speed _____

in/sec mm/sec

Dwell Time After Move _____ sec

NO. OF CYCLES _____

per minute per hour

HOLD POSITION? Required Not Required

After Move During Power Loss

NOTE: If load or force changes during cycle use the highest numbers for calculations

EXTEND

LOAD

lb. (U.S. Standard) kg. (Metric)

FORCE

lbf. (U.S. Standard) N (Metric)

RETRACT

LOAD

lb. (U.S. Standard) kg. (Metric)

FORCE

lbf. (U.S. Standard) N (Metric)

STROKE LENGTH _____

inch (US conventional) millimeters (Metric)

PRECISION

Repeatability _____
 inch millimeters

OPERATING ENVIRONMENT

Temperature, Contamination, Water, etc.

MOTION PROFILE

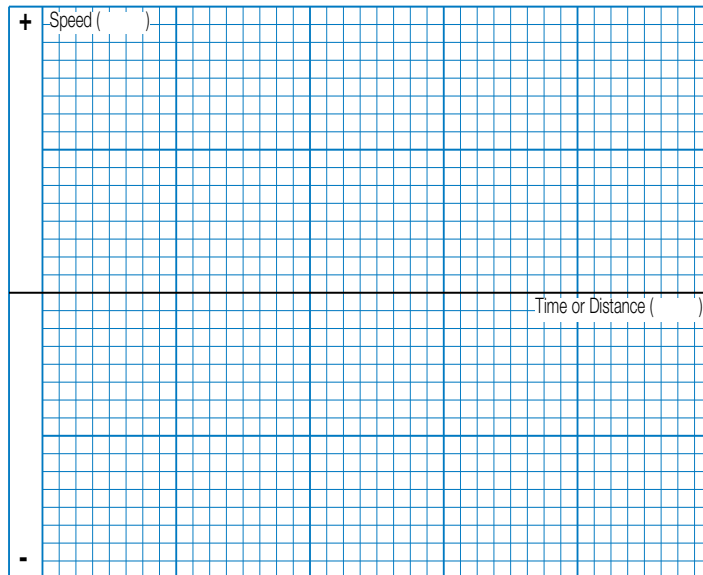

Graph your most demanding cycle, including accel/decel, velocity and dwell times. You may also want to indicate load variations and I/O changes during the cycle. Label axes with proper scale and units.

CONTACT INFORMATION

Name, Phone, Email
Co. Name, Etc.



USE THE TOLOMATIC SIZING AND SELECTION SOFTWARE AVAILABLE ONLINE AT www.tolomatic.com OR... CALL TOLOMATIC AT 1-800-328-2174.

We will provide any assistance needed to determine the proper actuator for the job.

FAX 1-763-478-8080

EMAIL help@tolomatic.com

ERD – Electric Rod-Style Actuator



Selection Guidelines

1 ESTABLISH MOTION PROFILE
Using the application stroke length, desired cycle time, loads and forces, establish the motion profile details including linear velocity and thrust in each of its segments.

2 SELECT ACTUATOR SIZE AND SCREW TYPE
Based on the required velocities and thrust select a size and screw type and lead of the ERD actuator.

3 VERIFY CRITICAL SPEED OF THE SCREW
Verify that the application's peak linear velocity does not exceed the critical speed value for the size and lead of the screw selected.

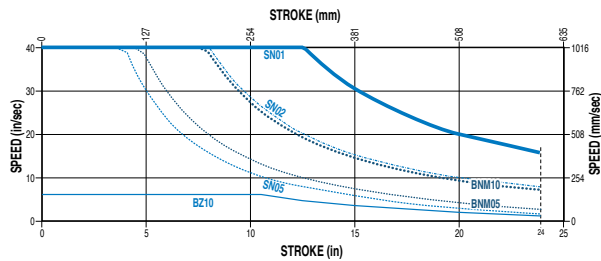

4 VERIFY AXIAL BUCKLING STRENGTH OF THE SCREW
Verify that the peak thrust does not exceed the critical buckling force for the size of the screw selected.

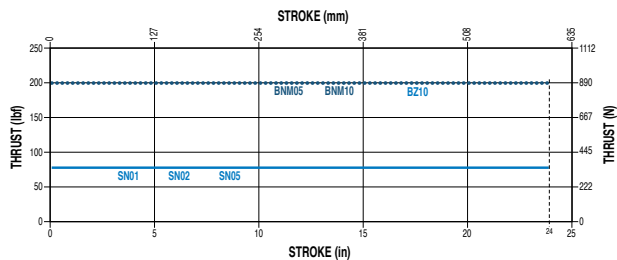

5 ESTABLISH TOTAL TORQUE REQUIREMENTS
Calculate total system inertia. The peak and RMS torque required from the motor to overcome internal friction, external forces and accelerate/decelerate the load.

6 VERIFY PV VALUE (IF ACME)
Verify that the PV value does not exceed the PV value for the size of the screw selected.

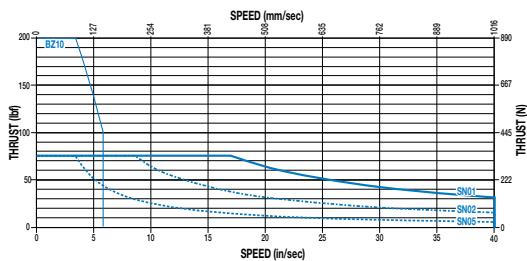

SPECIFICATIONS

7 CALCULATE LIFE (IF BALL SCREW)
Determine the practical load of the system to calculate the L10 estimated life.

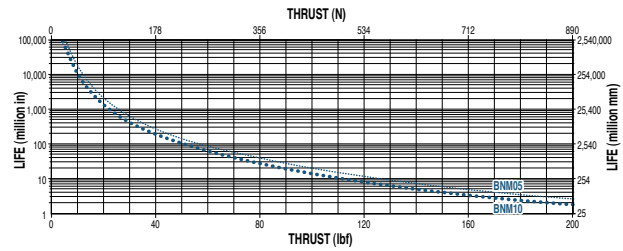

8 DETERMINE IF LOAD GUIDANCE IS NEEDED
If application requires carrying a load, anti-rotate, a tooling plate or there is risk of side loading the rod, choose the guided option. (GD2) Available sizes: 10, 15, 20

9 DETERMINE IF INGRESS PROTECTION AGAINST DUST AND WATER IS NEEDED.
If actuator is in contact with dust particulate, water or wash-down environment choose the IP67 or IP69K option. (IP67) Available sizes: 10, 15, 20; (IP69K) Available sizes: 10, 15 & 20

10 DETERMINE IF ENVIRONMENT IS CORROSIVE OR WASH DOWN
If corrosion resistance is required for 10-20 sizes, choose from two options of stainless steel components

- (SS1) ERD with all stainless steel components
- (SS2) ERD with all stainless steel components and protective motor enclosure. Contact Tolomatic for available motors.

11 SELECT MOUNTING AND SENSOR CHOICES
Mounting options include: TRR trunnion mount, FFG front flange mount, FM2 foot mount. 6 sensor choices include: reed, solid state PNP or NPN, all in normally open, with flying leads or quick-disconnect couplers.

12 SELECT ACTUATOR CONTROL SOLUTION
Add an extremely easy to use drive and motor combination to power the actuator.

ERD – Electric Rod-Style Actuator



SERVICE PARTS ORDERING

ERD ACTUATOR REPLACEMENT KITS

Code	Description	ERD SIZE		
		10	15	20
FFG	Front Flange Mount Kit	2191-1025	2192-1025	2193-1025
FM2	Foot Mount Kit	2191-9001	¹ 2192-9001	² 2193-9001
TRR	³ Trunnion Mount	0610-1044 (order 2)	6000-1785 (order 2)	2193-1018 (order 2)
IP67	⁴ IP67 Kit	2191-9201	2192-9201	2193-9201
IP69K	⁴ IP69K Kit	–	2192-9221	2193-9202
GD2	Guide Kit	Order via configurator code: GD2ERD__SM__._._		

- ¹ REPLACEMENT ONLY: If ERD15 unit was built with SS2 option, foot mount kit 2192-9203 is required.
- ² REPLACEMENT ONLY: If ERD20 unit was built with RP SS1 option, foot mount kit 2193-9209 is required.
- ³ REPLACEMENT ONLY: Trunnion mount option not available with SS2 option
- ⁴ REPLACEMENT ONLY: If used on an actuator that was not originally built with the IP67 option the thrust rod will retract below the Cap/Seal and may damage the seal

Code	Description	ERD SIZE	
		15	20
RA1	If replacing an actuator with CLV, SRE or ALC rod end option and want to use existing rod end, add RA1 to the end of the ordering code for thread compatibility. Do not reorder the rod end option.		

ERD SWITCHES

To order switch kits use configuration code for switch preceded by SW and actuator code.

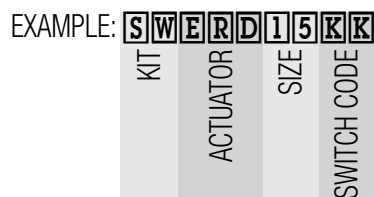

The example is for 3 Solid State NPN, Normally Open Switches with Quick-disconnect couplers. Each switch is complete with Bracket, Set Screw, Switch and mating QD cable.

Code	Lead	Normally	Sensor Type
R Y	5m (197 in)	Open	Reed
R K	Quick-disconnect		
T Y	5m (197 in)	Open	Solid State PNP
T K	Quick-disconnect		
K Y	5m (197 in)	Open	Solid State NPN
K K	Quick-disconnect		



sizeit.tolomatic.com for fast, accurate actuator selection or call Tolomatic (1-800-328-2174) with application information. We will provide any assistance needed to determine the proper actuator.



ERD – Electric Rod-Style Actuator



ORDERING

ERD 15 SN 02 SM 15 2-4 LMI ARI SS1 IP67 FFG KK2 YM

MODEL
ERD Rod-Style Actuator

SIZE
10, 15, 20,

NUT/SCREW COMBINATIONS

SIZE	CODE	TURNS/in (TPI)
10	SN	01, 02, 05
	BNM	05 mm lead
15	SN	01, 02, 05
	BNM	05, 10 mm lead
20	BNM	05, 10, 20 mm lead
	BZ	10

STROKE LENGTH

SM __ Enter desired stroke length in millimeters (25.4mm = 1 inch)

SIZE	MAXIMUM STROKE			
	SN or BN		Roller Nut	
	mm	in	mm	in
10	254.0	10	–	–
15,20	609.6	24	–	–

Contact Tolomatic with requests for longer strokes

MOTOR MOUNTING

LMI In-line motor mount
 RP1* 1:1 ratio, Reverse Parallel motor mount
 RP2* 2:1 ratio, Reverse Parallel motor mount

*RP is not available for the 10 size

Not all codes listed are compatible with all options. Contact Tolomatic with any questions.



NOTE: ERD22, ERD25, ERD30 ARE REPLACED BY THE IMPROVED DESIGN OF THE RSH22, RSH25, RSH30

OPTION ORDERING

ACTUATOR GUIDE & ANTI-ROTATE

GD2 Guided unit with 2 guide shafts & tooling plate
 Standard GD2 is aluminum body and 300 series stainless shafts even when ordered with SS1

ARI Internal Anti-Rotate for 15, 20 sizes only
 ❌ ARI not available for ERD10

ENVIRONMENTAL PROTECTION

SS1 Stainless steel actuator
 SS2_* Stainless steel actuator with protective motor enclosure
 SS21 NPT 1/2" conduit thread
 SS22 M20x1.5 conduit thread
 SS23 Cord grip(s), 1 or 2 grips determined by encoder choice

IP67 & IP69K See chart below (IP ratings defined on pg. ERD_9)
 LUB Food grade grease

*NOTE: Contact Tolomatic for motors available with SS2 option
 ❌ *SS2 is not available with GD2 option

NOTE: IP69K available only together with SS1 or SS2 option

ACTUATOR MOUNTING

FFG** Front Flange Mount
 TRM Trunnion Mounting, Rear (metric)
 TRR Trunnion Mounting, Rear (US standard)
 FM2** Foot Mount
 §PCD1 Rear Clevis Mounting inch/Imperial pin size
 §PCD2 Rear Clevis Mounting metric pin size

**NOTE: Foot Mount and Front Flange Mount are shipped together with the actuator but are not installed by Tolomatic.
 § RP motor mount ONLY: 15, 20 sizes

Size	IP RATING CHOICES AVAILABLE			MOTOR ENCLOSURE AVAILABLE
	IP40	IP67	IP69K	
10	Std.	YES	YES	YES
15	Std.	YES	YES	YES
20	Std.	YES	YES	YES

ROD END

Externally threaded rod end is standard
 CLV Clevis Rod End
 SRE Spherical Rod End
 ALC Alignment Coupler Rod End

NOTE: Rod End options above are not available for all ERD sizes. Stainless steel available for the above rod ends in limited sizes. Contact Tolomatic

For replacement actuator compatible with existing rod end options see RA1 code (previous page)

SWITCHES**

TYPE	LOGIC	NORMALLY	QUICK-DISCONNECT	CODE	QUANTITY	LEAD LENGTH
REED	SPST	Open	No	RY	After code enter quantity desired	5 m (16.4 feet) 6 in (152mm) to QD connector w/ 5m lead
SOLID STATE	PNP	Open	No	TY		
	NPN	Open	No	KY		
			Yes	KK		

**NOTE: Switches are shipped together with the actuator but are not installed by Tolomatic.

YOUR MOTOR HERE

YM ___ Motor mount for non-Tolomatic motor.

Brakes mounted on reverse parallel motor mounts (especially in vertically positioned actuators) will not prevent back driving of the screw and the load falling under gravity in the event of a timing belt failure. An inline motor mount with a fail-safe brake mounted directly to the actuator shaft or a special geared or thru-shaft reverse parallel construction should be considered if a brake is required in a safety critical application. Contact Tolomatic for alternate reverse parallel brake mounting options.

Gearheads may be used with reverse parallel motor mounts. However, the torque on the belt and internal RP components must remain below the capabilities of the assembly to prevent belt slipping or premature failure. Contact Tolomatic for additional information if required.

AM ___ Tolomatic motor: contact factory

Configure an actuator and a complete motion control system today using Tolomatic's easy-to-use on-line sizing & selection



The Tolomatic Difference Expect More From the Industry Leader:



INNOVATIVE PRODUCTS

Solutions with Endurance TechnologySM for challenging applications.



FAST DELIVERY

Built-to-order with configurable stroke lengths and flexible mounting options.

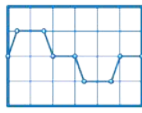

ACTUATOR SIZING

Size and select electric actuators with our online software.



YOUR MOTOR HERE[®]

Match your motor to compatible mounting plates with Tolomatic actuators.



CAD LIBRARY

Download 2D or 3D CAD files for Tolomatic products.



TECHNICAL SUPPORT

Get a question answered or request a virtual design consultation with one of our engineers.

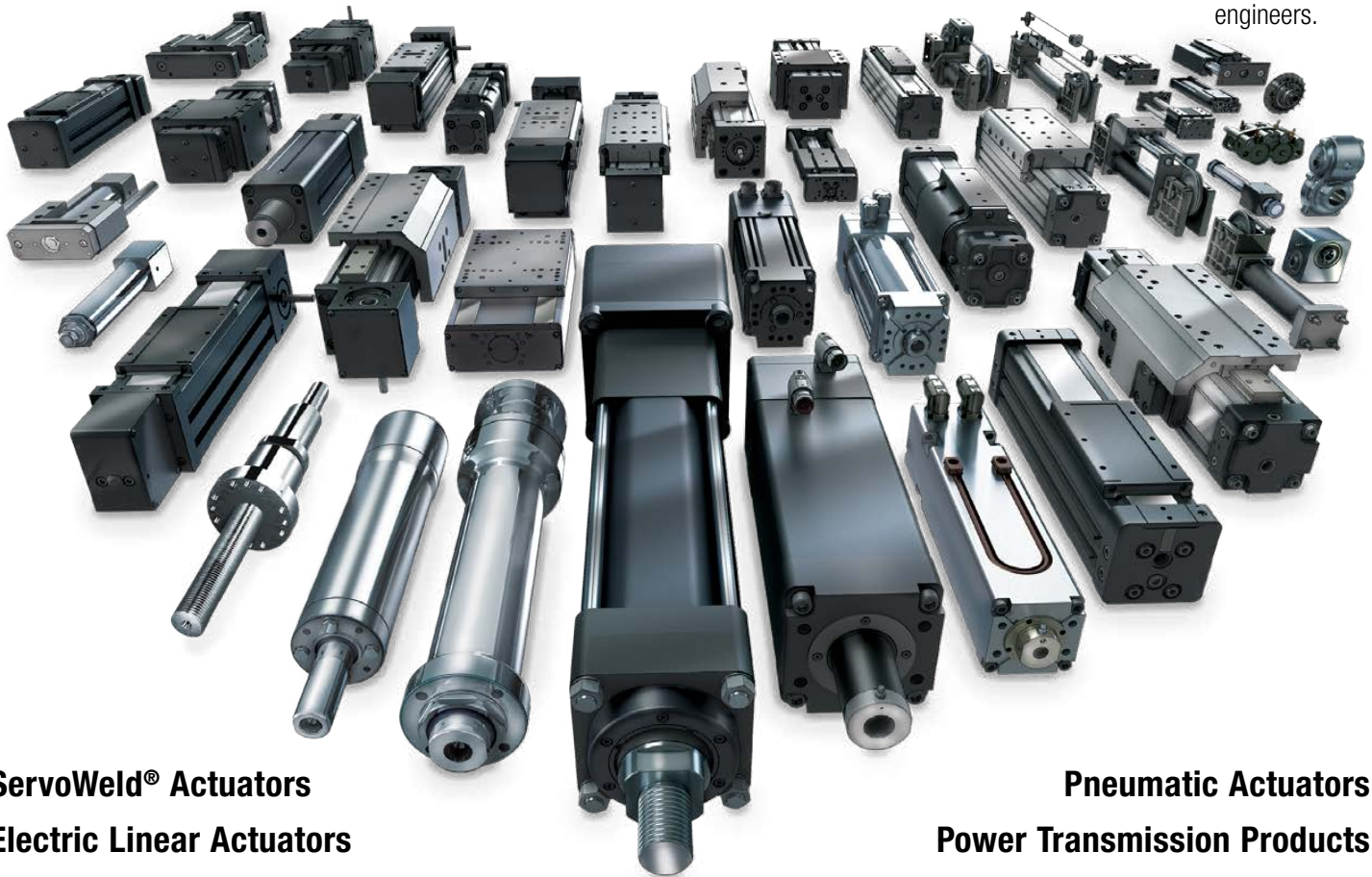

ServoWeld[®] Actuators
Electric Linear Actuators

Pneumatic Actuators
Power Transmission Products



MADE IN U.S.A.

TolomaticTM

EXCELLENCE IN MOTION

COMPANY WITH
QUALITY SYSTEM
CERTIFIED BY DNV
= ISO 9001 =
Certified site: Hamel, MN

USA - Headquarters

Tolomatic Inc.
3800 County Road 116
Hamel, MN 55340, USA
Phone: (763) 478-8000
Toll-Free: **1-800-328-2174**
sales@tolomatic.com
www.tolomatic.com

MEXICO

Centro de Servicio
Parque Tecnológico Innovación
Int. 23, Lateral Estatal 431,
Santiago de Querétaro,
El Marqués, México, C.P. 76246
Phone: +1 (763) 478-8000
help@tolomatic.com

EUROPE

Tolomatic Europe GmbH
Elisabethenstr. 20
65428 Rüsselsheim
Germany
Phone: +49 6142 17604-0
help@tolomatic.eu
www.tolomatic.com/de-de

CHINA

Tolomatic Automation Products (Suzhou) Co. Ltd.
No. 60 Chuangye Street, Building 2
Huqiu District, SND Suzhou
Jiangsu 215011 - P.R. China
Phone: +86 (512) 6750-8506
Tolomatic_China@tolomatic.com

All brand and product names are trademarks or registered trademarks of their respective owners. Information in this document is believed accurate at time of printing. However, Tolomatic assumes no responsibility for its use or for any errors

that may appear in this document. Tolomatic reserves the right to change the design or operation of the equipment described herein and any associated motion products without notice. Information in this document is subject to change without notice.

Visit www.tolomatic.com for the most up-to-date technical information